

# Panasonic®

## DVD Home Theater Sound System Operating Instructions

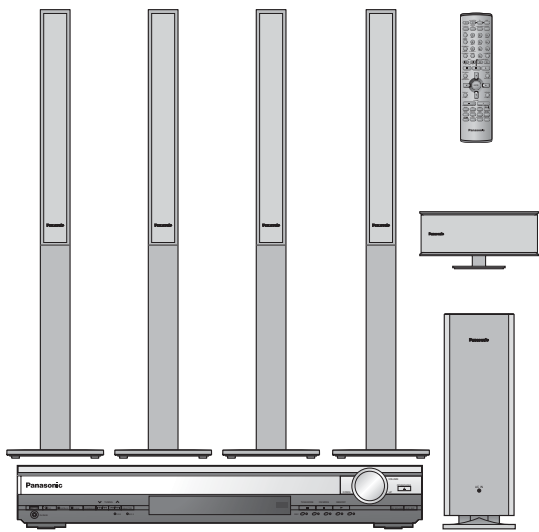

The illustration shows SC-HT900.

Model No. **SC-HT900**  
**SC-HT700/SC-HT690**

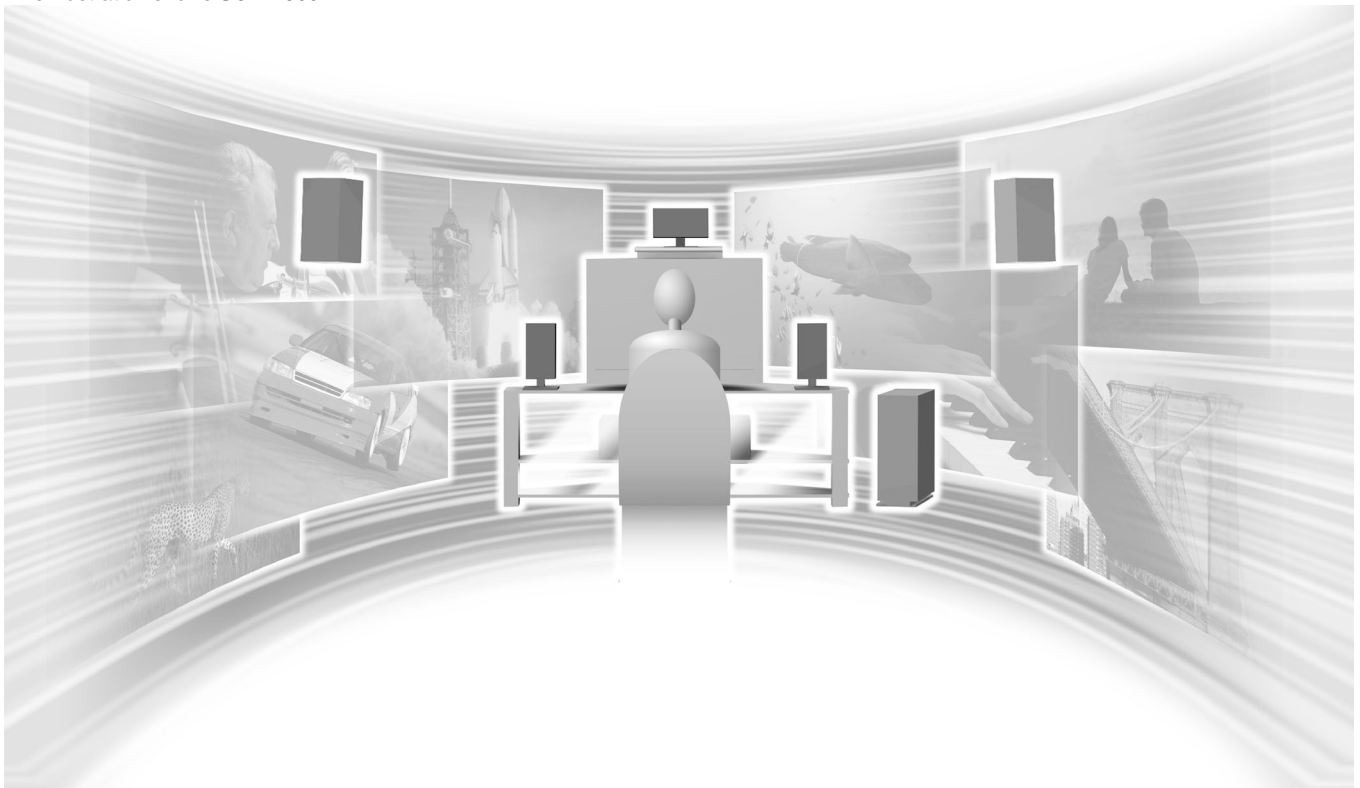

Before connecting, operating or adjusting this product, please read these instructions completely. Please keep this manual for future reference.



For U.S.A.



As an ENERGY STAR® Partner, Panasonic has determined that this product meets the ENERGY STAR® guidelines for energy efficiency.

### Region number supported by this player

Region numbers are allocated to DVD players and software according to where they are sold.

**For U.S.A., Canada, and units with PX printed on the outer packaging**

- The region number of this player is "1".
- The player will play DVD-Video marked with labels containing "1" or "ALL".



**For Latin America**

- The region number of this player is "4".
- The player will play DVD-Video marked with labels containing "4" or "ALL".



For U.S.A. only

**The warranty can be found on page 43.**

# Dear customer

Thank you for purchasing this product.  
For optimum performance and safety, please read these instructions carefully.

**HT900** : indicates features applicable to SC-HT900 only.

**HT700** : SC-HT700 only.

**HT690** : SC-HT690 only.

- These operating instructions are applicable to models SC-HT900, SC-HT700 and SC-HT690.
- Unless otherwise indicated, illustrations in these operating instructions are of SC-HT900 for U.S.A. and Canada.
- Operations in these instructions are described mainly with the remote control, but you can do the operations on the main unit if the controls are the same.

Getting started

System	SC-HT900	SC-HT700	SC-HT690
Main unit	SA-HT900	SA-HT700	SA-HT690
Front speakers	SB-FS900	SB-FS803A	SB-FS803A
Center speaker	SB-PC701	SB-PC703	SB-PC703
Surround speakers	SB-FS900	SB-FS803A	SB-FS803A
Active subwoofer	SB-WA350	SB-WA340	SB-WA342

## CAUTION!

THIS PRODUCT UTILIZES A LASER.  
USE OF CONTROLS OR ADJUSTMENTS OR PERFORMANCE OF PROCEDURES OTHER THAN THOSE SPECIFIED HEREIN MAY RESULT IN HAZARDOUS RADIATION EXPOSURE. DO NOT OPEN COVERS AND DO NOT REPAIR YOURSELF. REFER SERVICING TO QUALIFIED PERSONNEL.

## WARNING:

TO REDUCE THE RISK OF FIRE, ELECTRIC SHOCK OR PRODUCT DAMAGE, DO NOT EXPOSE THIS APPARATUS TO RAIN, MOISTURE, DRIPPING OR SPLASHING AND THAT NO OBJECTS FILLED WITH LIQUIDS, SUCH AS VASES, SHALL BE PLACED ON THE APPARATUS.

THE FOLLOWING APPLIES ONLY IN THE U.S.A. AND CANADA:

## CAUTION:

TO PREVENT ELECTRIC SHOCK MATCH WIDE BLADE OF PLUG TO WIDE SLOT, FULLY INSERT.

## CAUTION!

- DO NOT INSTALL OR PLACE THIS UNIT IN A BOOKCASE, BUILT-IN CABINET OR IN ANOTHER CONFINED SPACE. ENSURE THE UNIT IS WELL VENTILATED. TO PREVENT RISK OF ELECTRIC SHOCK OR FIRE HAZARD DUE TO OVERHEATING, ENSURE THAT CURTAINS AND ANY OTHER MATERIALS DO NOT OBSTRUCT THE VENTILATION VENTS.
- DO NOT OBSTRUCT THE UNIT'S VENTILATION OPENINGS WITH NEWSPAPERS, TABLECLOTHS, CURTAINS, AND SIMILAR ITEMS.
- DO NOT PLACE SOURCES OF NAKED FLAMES, SUCH AS LIGHTED CANDLES, ON THE UNIT.
- DISPOSE OF BATTERIES IN AN ENVIRONMENTALLY FRIENDLY MANNER.

For units with PX printed on the outer packaging THIS UNIT IS INTENDED FOR USE IN MODERATE CLIMATES.  
For Latin America THIS UNIT IS INTENDED FOR USE IN TROPICAL CLIMATES.

For areas except U.S.A. and Canada

## CAUTION:

The AC voltage is different according to the area.  
Be sure to set the proper voltage in your area before use.  
(For details, please refer to page 10.)

<b>CAUTION</b>	- LASER RADIATION WHEN OPEN. DO NOT STARE INTO BEAM. FDA 21 CFR / Class II
<b>CAUTION</b>	- VISIBLE AND INVISIBLE LASER RADIATION WHEN OPEN. AVOID EXPOSURE TO BEAM. IEC60825-1 / Class 3b
<b>VARNING</b>	- SYNLIG OCH OSYNLIG LASERSTRÅLNING NÄR DENNA DEL ÄR ÖPPNAD. BETRÄKTA EJ STRÅLEN.
<b>ADVARSEL</b>	- SYNLIG OG USYNLIG LASERSTRÅLING VED ÅBNING. UNDGÅ UDSETTELSE FOR STRÅLING.
<b>ADVARSEL</b>	- SYNLIG OG USYNLIG LASERSTRÅLING NÄR DEKSEL ÄR ÖPPEN. UNDGÅ EXPOSITION FÖR STRÅLEN.
<b>VARO!</b>	- AVATTAESSA OLET ALLTIIN NÄKYVÄÄ JA NÄKYMÄTÖN LASERSÄTELYLLÄ. ÄLÄ KATSO SÄTEESEEN.
<b>VORSICHT</b>	- SICHTBARE UND UNSICHTBARE LASERSTRÄHLUNG, WENN ABDECKUNG GEÖFFNET. NICHT IN DEN STRAHL AUSSETZEN.
<b>ATTENTION</b>	- RAYONNEMENT LASER VISIBLE ET INVISIBLE EN CAS D'OUVERTURE. EXPOSITION DANGEREUSE AU FAISCEAU.
<b>注意</b>	- 打開時有可見及不可見激光射。避免激光束照射。
<b>注意</b>	- ここを開くと可視及び不可視レーザー光が出ます。ビームを見たり、触れたりしないで下さい。 H0LX30084

(Inside of product)

THE FOLLOWING APPLIES ONLY IN THE U.S.A.:

## CAUTION:

This equipment has been tested and found to comply with the limits for a Class B digital device, pursuant to Part 15 of the FCC Rules.

These limits are designed to provide reasonable protection against harmful interference in a residential installation. This equipment generates, uses and can radiate radio frequency energy and, if not installed and used in accordance with the instructions, may cause harmful interference to radio communications. However, there is no guarantee that interference will not occur in a particular installation. If this equipment does cause harmful interference to radio or television reception, which can be determined by turning the equipment off and on, the user is encouraged to try to correct the interference by one or more of the following measures:

- Reorient or relocate the receiving antenna.
- Increase the separation between the equipment and receiver.
- Connect the equipment into an outlet on a circuit different from that to which the receiver is connected.
- Consult the dealer or an experienced radio/TV technician for help.

Any unauthorized changes or modifications to this equipment would void the user's authority to operate this device.

This device complies with Part 15 of the FCC Rules. Operation is subject to the following two conditions: (1) This device may not cause harmful interference, and (2) this device must accept any interference received, including interference that may cause undesired operation.

THE FOLLOWING APPLIES ONLY IN THE U.S.A. AND CANADA:



## CAUTION

RISK OF ELECTRIC SHOCK  
DO NOT OPEN



CAUTION: TO REDUCE THE RISK OF ELECTRIC SHOCK, DO NOT REMOVE SCREWS. NO USER-SERVICEABLE PARTS INSIDE. REFER SERVICING TO QUALIFIED SERVICE PERSONNEL.

The lightning flash with arrowhead symbol, within an equilateral triangle, is intended to alert the user to the presence of uninsulated "dangerous voltage" within the product's enclosure that may be of sufficient magnitude to constitute a risk of electric shock to persons.

The exclamation point within an equilateral triangle is intended to alert the user to the presence of important operating and maintenance (servicing) instructions in the literature accompanying the appliance.

# Accessories



Please check and identify the supplied accessories. Use numbers indicated in parentheses when asking for replacement parts.

(Only for U.S.A.)

To order accessories contact 1-800-332-5368 or web site (<http://www.panasonic.com>).

(For other areas)

To order accessories, call the dealer from whom you have made your purchase.

- 1 Remote control  
HT900  
(EUR7623X70)  
HT700 HT690  
(EUR7623X60)

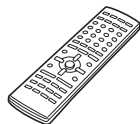

- 2 Batteries  
for remote control



- 1 AC power supply cord  
For U.S.A. and Canada  
(RJA0065-1D)

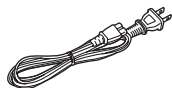

For others  
(RJA0019-2X)

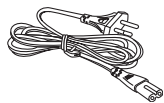

- 1 Video cable  
(RJL1P016B15A)



For areas except U.S.A. and Canada

- 1 Power plug adaptor  
(SJP5213-2)

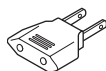

- 1 AM loop antenna  
(N1DADYY00002)



- 1 FM indoor antenna  
(RSA0006-J)



- 1 System cable  
(K1HA25HA0001)



- 5 Speaker cables  
(RFA2163-J)  
3×4-m (13-foot) cables  
2×10-m (33-foot) cables



- 1 Sheet of speaker-cable stickers

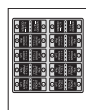

- HT900  
 8 Silver screws  
(XSN5+16FN)



- HT900  
 4 Black screws  
(XTB3+10JFZ)



- HT900  
 4 Clips  
(QWBG002AA)



### Note

The included AC power supply cord is for use with this unit only. Do not use it with other equipment.

For areas except U.S.A. and Canada



(Back of product)

# Table of contents

## Getting started

Accessories .....	3
IMPORTANT SAFETY INSTRUCTIONS .....	4
Disc information .....	5

### Simple setup

<b>STEP1</b> HT900 Assembly and connection of front and surround speakers .....	6
Locating .....	7
HT700 HT690 Locating .....	7
<b>STEP2</b> HT900 Connecting speakers with the subwoofer .....	8
HT700 HT690 Connecting speakers with the subwoofer .....	8
<b>STEP3</b> Television .....	9
<b>STEP4</b> Connecting the subwoofer, antennas, and AC power supply cord .....	10
<b>STEP5</b> The remote control .....	10
<b>Other speaker setup options</b> .....	11
<b>STEP6 QUICK SETUP</b> .....	12

Control reference guide .....	13
-------------------------------	----

## Disc operations

<b>Discs—Basic play</b> .....	14
Sequential play/Changing the disc in the play position .....	15
Changing other discs during play/Position Memory function .....	15
Replaying a scene—QUICK REPLAY .....	15
Starting play from a selected item .....	16
Selecting still pictures—Page Skip .....	16
Skipping items/Fast forward and rewind—SEARCH .....	16
Slow-motion play/Frame-by-frame viewing .....	16
<b>Discs—Convenient functions</b> .....	17
Selecting groups to play/Repeat play/A-B repeat play .....	17
Soundtracks/Subtitles .....	18
All group play/Program play/Random play .....	19
Marking places to play again/Variable Zoom function .....	20
<b>Playing the programs or play lists on DVD-RAM</b> .....	21
Selecting a program to play—DIRECT NAVIGATOR .....	21
Using the play list menu .....	21
<b>WMA/MP3, CD text and JPEG navigation menus</b> .....	22
Playing HighMAT discs .....	23
<b>Using On-Screen Menu Icons</b> .....	24
Common procedures/Progress indicator .....	24
Disc information/Unit information .....	25

## Radio operations

<b>The radio</b> .....	27
Manual tuning/Preset tuning .....	27

## Sound field/sound quality operations

<b>Sound field</b> .....	28
Dolby Digital and DTS/Dolby Pro Logic or Dolby Pro Logic II .....	28
Speaker level adjustments .....	28
Super Surround/Sound Field Control/Center Focus .....	29
Multi Rear Surround (M.R.S)/Virtual Rear Surround (V.R.S) .....	29
Seat Position .....	29
Custom Sound Memory—Store the sound settings .....	30
Changing the delay time .....	30
<b>Sound quality</b> .....	31
Adjusting the bass .....	31
Double re-master—Enjoying more natural sound .....	31
DR COMP—Dynamic range compression .....	31

## Other functions

<b>Convenient functions</b> .....	31
Muting the volume/Dimming the display .....	31
The sleep timer/Using headphones .....	31
<b>Operating other equipment</b> .....	32
<b>Changing settings</b> .....	34
<b>Optional antenna connections</b> .....	36

## Reference

<b>Glossary</b> .....	37
<b>Specifications</b> .....	38
<b>Troubleshooting guide</b> .....	40
<b>Product Service (U.S.A. and Canada)</b> .....	42
<b>Maintenance</b> .....	42
<b>Limited Warranty (U.S.A.)</b> .....	43







# IMPORTANT SAFETY INSTRUCTIONS

Read these operating instructions carefully before using the unit. Follow the safety instructions on the unit and the applicable safety instructions listed below. Keep these operating instructions handy for future reference.

- 1) Read these instructions.
- 2) Keep these instructions.
- 3) Heed all warnings.
- 4) Follow all instructions.
- 5) Do not use this apparatus near water.
- 6) Clean only with dry cloth.
- 7) Do not block any ventilation openings. Install in accordance with the manufacturer's instructions.
- 8) Do not install near any heat sources such as radiators, heat registers, stoves, or other apparatus (including amplifiers) that produce heat.
- 9) Do not defeat the safety purpose of the polarized or grounding-type plug. A polarized plug has two blades with one wider than the other. A grounding-type plug has two blades and a third grounding prong. The wide blade or the third prong are provided for your safety. If the provided plug does not fit into your outlet, consult an electrician for replacement of the obsolete outlet.
- 10) Protect the power cord from being walked on or pinched particularly at plugs, convenience receptacles, and the point where they exit from the apparatus.
- 11) Only use attachments/accessories specified by the manufacturer.
- 12) Use only with the cart, stand, tripod, bracket, or table specified by the manufacturer, or sold with the apparatus. When a cart is used, use caution when moving the cart/apparatus combination to avoid injury from tip-over.
- 13) Unplug this apparatus during lightning storms or when unused for long periods of time.
14. Refer all servicing to qualified service personnel. Servicing is required when the apparatus has been damaged in any way, such as power-supply cord or plug is damaged, liquid has been spilled or objects have fallen into the apparatus, the apparatus has been exposed to rain or moisture, does not operate normally, or has been dropped.



## ■ Discs that can be played

Disc type	Logo	Indication used in instructions
DVD-RAM		<b>RAM</b>
DVD-Audio		<b>DVD-A</b>
DVD-Video		<b>DVD-V</b>
DVD-R		
Video CD		<b>VCD</b> Including SVCD (Confirming to IEC62107)
CD		<b>CD</b> Including CD text
CD-R/RW	—	<b>WMA</b> <b>MP3</b> <b>JPEG</b>

- Use discs with the above logos and that conform to specifications. The unit cannot play other discs correctly.
- Do not use irregularly shaped discs (e.g. heart-shaped), as these can damage the unit.

## ■ Discs that cannot be played

PAL discs (except DVD-Audio), DVD-ROM, CD-ROM, CDV, CD-G, +RW, DVD-RW, CVD, SACD, Divx Video Discs, Photo CD and “Chaoji VCD” available on the market including CVD, DVCD and SVCD that do not conform to IEC62107.

## ■ Disc structure

Disc structure and the labels given to the items on discs depend on the disc type.

- Track:** the smallest division on DVD-Audio, CDs and Video CDs, or a single WMA/MP3 file.
- Chapter:** the smallest division on DVD-Video.
- Group:** collections of tracks on DVD-Audio and equivalent to folders or albums on data discs.
- Title:** the largest division on DVD-Video, usually an entire movie.
- Program:** the division on DVD-RAM equivalent to a single recording.
- Picture:** a single JPEG file.
- Play list:** the largest grouping on a HighMAT disc, or a group of scenes on DVD-RAM.
- Scene:** DVD-RAM program sections specified and grouped into play lists on a DVD video recorder.
- Content:** covers tracks and pictures on HighMAT discs.

## Playing DVDs and Video CDs

The producer of these discs can control how they are played so you may not always be able to control play as described in these operating instructions (for example if the play time is not displayed or if a Video CD has menus). Read the disc's instructions carefully.

## ■ DVD-RAM discs

DVD-RAM discs must meet the following conditions for this unit to be able to play them.

Type	<ul style="list-style-type: none"> <li>• Non-cartridge discs</li> <li>• Discs that can be removed from their cartridges (TYPE 2 and 4)</li> </ul>
Capacity	<ul style="list-style-type: none"> <li>• 12 cm (5") 9.4 GB (double-sided) and 4.7 GB (single-sided)</li> <li>• 8 cm (3") 2.8 GB (double-sided)</li> </ul>
Recording format	Discs recorded with DVD video recorders, DVD video cameras, personal computers, etc., using Version 1.1 of the Video Recording Format (a unified video recording standard).

- Remove TYPE 2 and 4 discs from their cartridges before use, then return them when you are finished. Read the instructions for the disc carefully.
- Do not allow the disc to become dirty or scratched. Store discs in their cartridges and ensure the disc label and cartridge label face the same way.
- Some parts of the disc, for example where one program ends and another begins, may not play smoothly.

## ■ DVD-R discs

Panasonic DVD-R recorded and finalized on a Panasonic DVD video recorder are played as DVD-Video on this unit.

## ■ CD-R and CD-RW discs

This unit can play CD-R/RW (audio recording disc) recorded with CD-DA, video CD, SVCD (conforming to IEC62107), WMA, MP3 or JPEG. Close the sessions or finalize the disc after recording.

## ■ HighMAT discs

This unit is compatible with HighMAT discs containing WMA, MP3, and/or JPEG files.

### Note

It may not be possible to play CD-R, CD-RW, DVD-R and DVD-RAM in all cases due to the type of disc or condition of the recording.

## ■ Playing PAL system DVD-Audio

This unit converts PAL to NTSC for play. The picture is compressed to show it in its entirety, but this may cause it to be stretched vertically.

## ■ To clean discs

### DVD-Audio, DVD-Video, Video CD, CD

Wipe with a damp cloth and then wipe dry.



### DVD-RAM, DVD-R

- Clean with an optional DVD-RAM/PD disc cleaner (LF-K200DCA1, where available).
- Never use cloths or cleaners for CDs etc.

## ■ Handling precautions

- Do not write on the label side with a ball-point pen or other writing instrument.
- Do not use record cleaning sprays, benzene, thinner, static electricity prevention liquids or any other solvent.
- Do not attach labels or stickers to discs. (Do not use discs with exposed adhesive from tape or left over peeled-off stickers.)
- Do not use scratch-proof protectors or covers.
- Do not use discs printed with label printers available on the market.

# Simple setup

## STEP 1

HT900

### Assembly and connection of front and surround speakers

4 Speaker units



4 Stands



4 Bases



Speaker cables

- 2×4-m (13-foot) cables
- 2×10-m (33-foot) cables



8 Silver screws

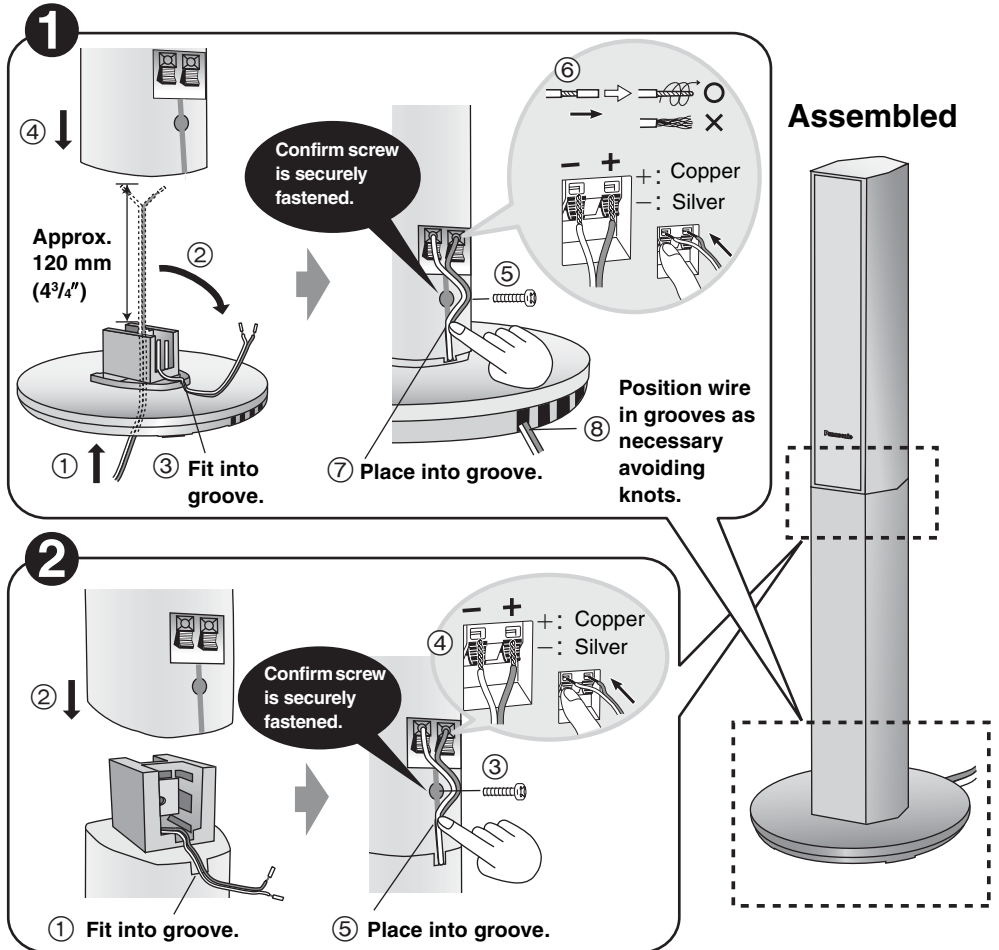

- You can attach the speakers directly to their bases (if you want to put them on shelves, for example).

#### Note

- Never short-circuit positive (+) and negative (-) speaker wires.
- Be sure to connect only positive (copper) wires to positive (+) terminals and negative (silver) wires to negative (-) terminals. Incorrect connection can damage the speakers.

# STEP 1

HT700

HT690

## Locating

## Locating

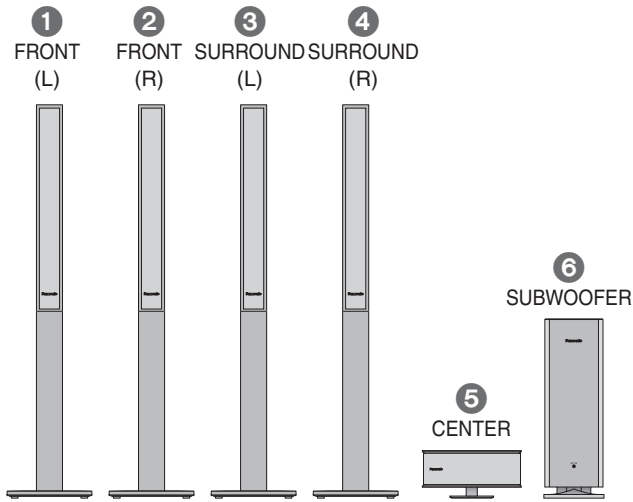

Setup example

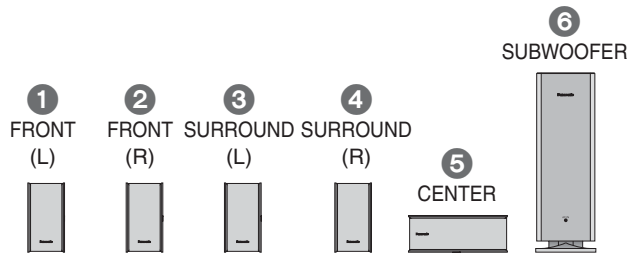
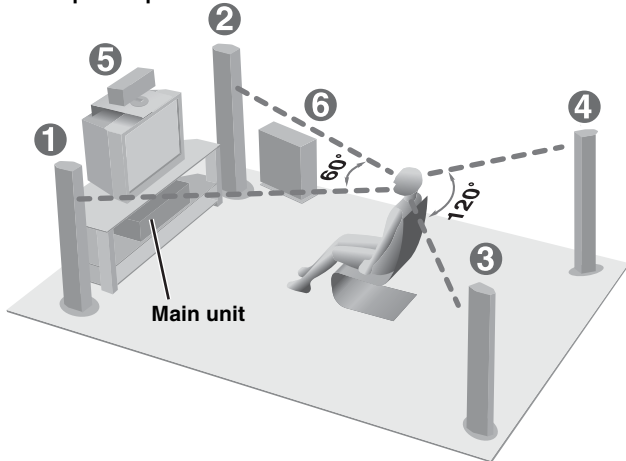

Setup example

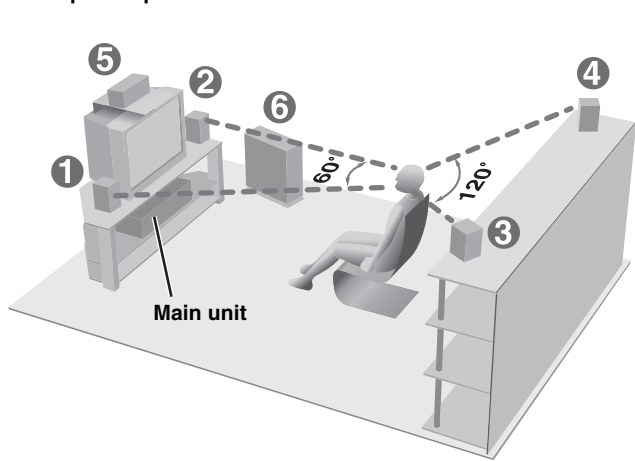

- The front and surround speakers are the same. Use those you have connected the short cords to as front speakers and those you have connected the long cords to as surround speakers.
- Place the front, center, and surround speakers at approximately the same distance from the seating position. The angles in the diagram are approximate.

### Use only supplied speakers

Using other speakers can damage the unit and sound quality will be negatively affected.

- Set the speakers up on an even surface to prevent them from falling. Take proper precautions to prevent the speakers from falling if you cannot set them up on an even surface.

### Positioning for best effect

How you set up your speakers can affect the bass and the sound field. Note the following points.

- Place speakers on flat secure bases.
- Placing speakers too close to floors, walls, and corners can result in excessive bass. Cover walls and windows with thick curtain.

### Caution

Hold the speakers by the sides. Applying pressure to the front net can damage the speaker.

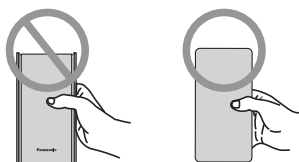

### Main unit

#### Note

Keep your speakers at least 10 mm (13/32") away from the system for proper ventilation.

### Center speaker

- You can also put this speaker directly under the television.
- Vibration caused by the center speaker can disrupt the picture if it is placed directly on the television. Put the center speaker on a rack or shelf.

### Subwoofer

Place to the right of the television, on the floor or a sturdy shelf so that it won't cause vibration.

Leave 10 cm (4") on the right for the woofer to be effective. Leave 10 cm (4") at the rear for ventilation.

# STEP 2 HT900

## Connecting speakers with the subwoofer

Attach the speaker-cable stickers to make connection easier.

Simple setup

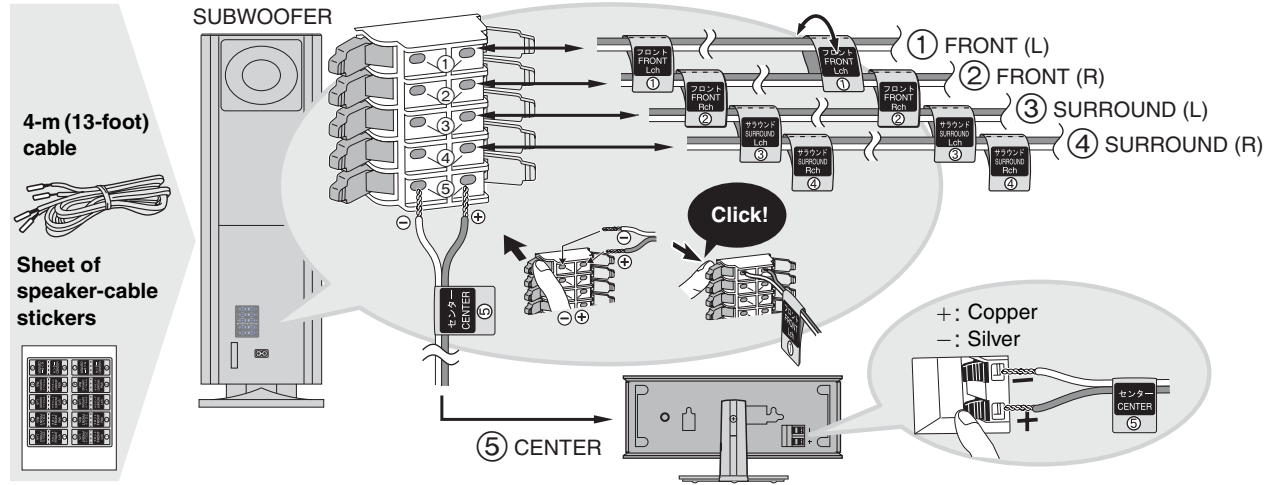

### ■ Preventing the speakers from falling over

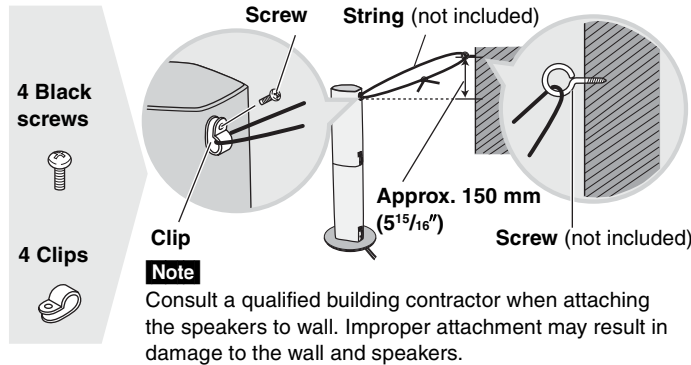

### ■ Keeping the cables out of the way

Pass the cables through the holes in the stand to keep them out of the way.

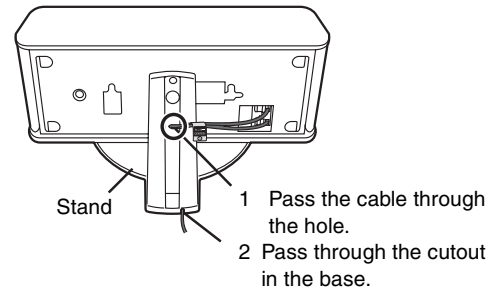

# STEP 2 HT700 HT690

## Connecting speakers with the subwoofer

Attach the speaker-cable stickers to make connection easier.

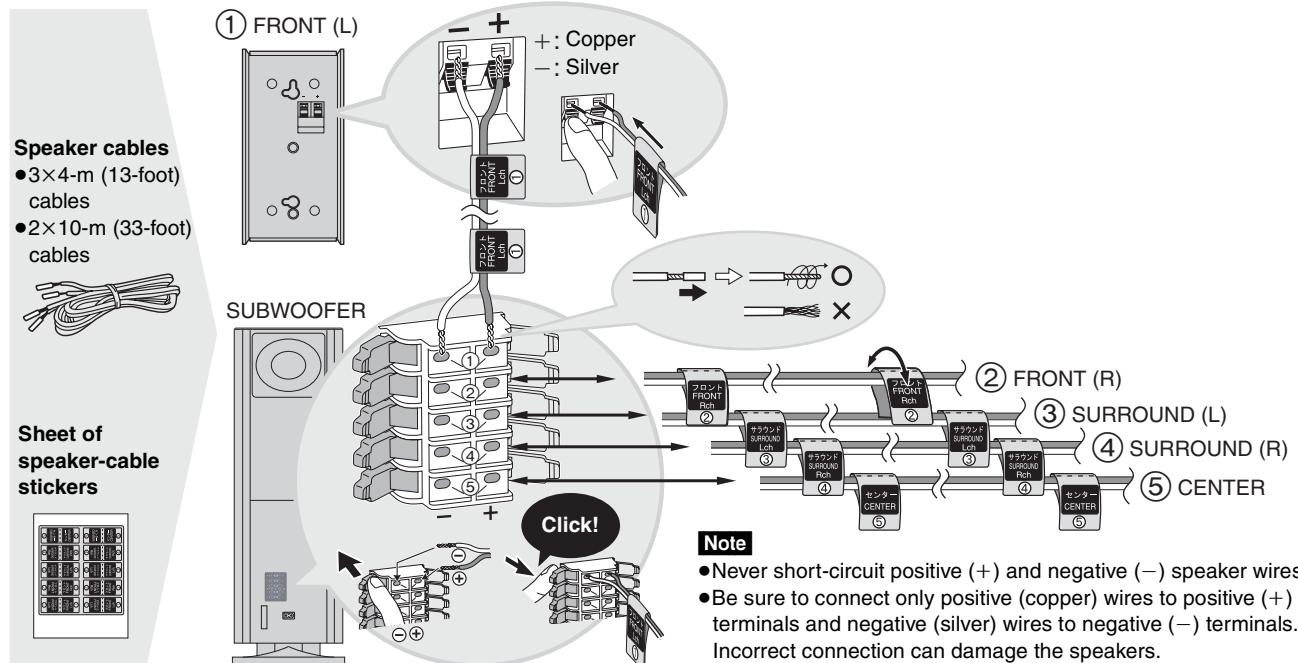



# STEP 3 Television

Video cable



## ■ Connecting a television with a VIDEO IN terminal

Television  
(not included)

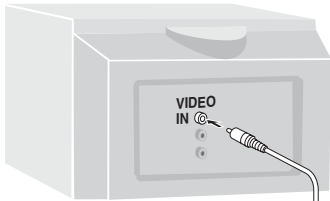

Video cable  
(included)

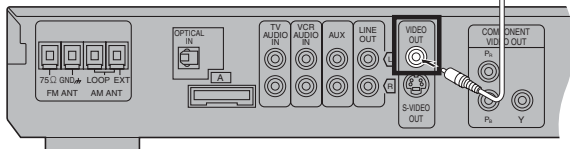

**Connect directly to your television.**

Do not connect the unit through a video cassette recorder, because the picture may not be played correctly due to the copy guard.

## ■ Connecting a television with COMPONENT VIDEO IN terminals

COMPONENT  
VIDEO IN

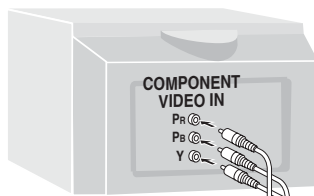

Video cables  
(not included)

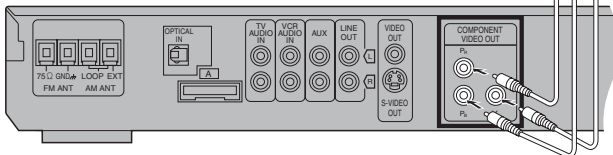

### COMPONENT VIDEO OUT terminals

These terminals can be used for either interlace or progressive output and provide a purer picture than the S-VIDEO OUT terminal. Connection using these terminals outputs the color difference signals (P<sub>B</sub>/P<sub>R</sub>) and luminance signal (Y) separately in order to achieve high fidelity in reproducing colors.

- The description of the component video input terminals depends on the television or monitor (e.g. Y/P<sub>B</sub>/P<sub>R</sub>, Y/B-Y/R-Y, Y/C<sub>B</sub>/C<sub>R</sub>). Connect to terminals of the same color.
- After making this connection, change the black level for a better picture (➔ page 34, Video—Black Level Control).

### To enjoy progressive video

- Connect to the component video (480P) input terminals on a television compatible with this unit's copy guard system. (Video will not be displayed correctly if connected to an incompatible television.)
- Press [PROGRESSIVE] on the main unit so "PROG." appears on the display (➔ page 14).
- All televisions manufactured by Panasonic and that have 480P input connectors are compatible. Consult the manufacturer if you have another brand of television.

## ■ Connecting a television with an S-VIDEO IN terminal

S-VIDEO  
IN

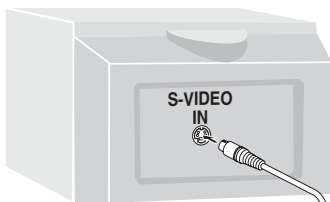

S-video cable (not included)

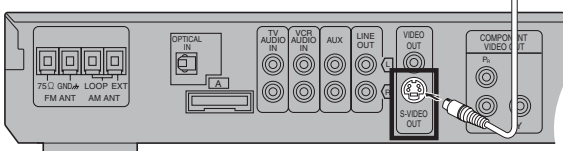

### S-VIDEO OUT terminal

The S video terminal achieves a more vivid picture than the VIDEO OUT terminal by separating the chrominance (C) and luminance (Y) signals. (Actual results depend on the television.)

# STEP 4 Connecting the subwoofer, antennas, and AC power supply cord

System cable

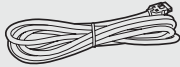

AM loop antenna



FM indoor antenna



AC power supply cord  
For U.S.A. and Canada

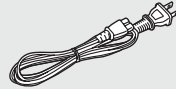

For others

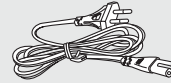

Power plug adaptor

For areas except U.S.A. and Canada

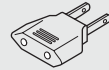

Connect the AC power supply cord after all other connections are complete.

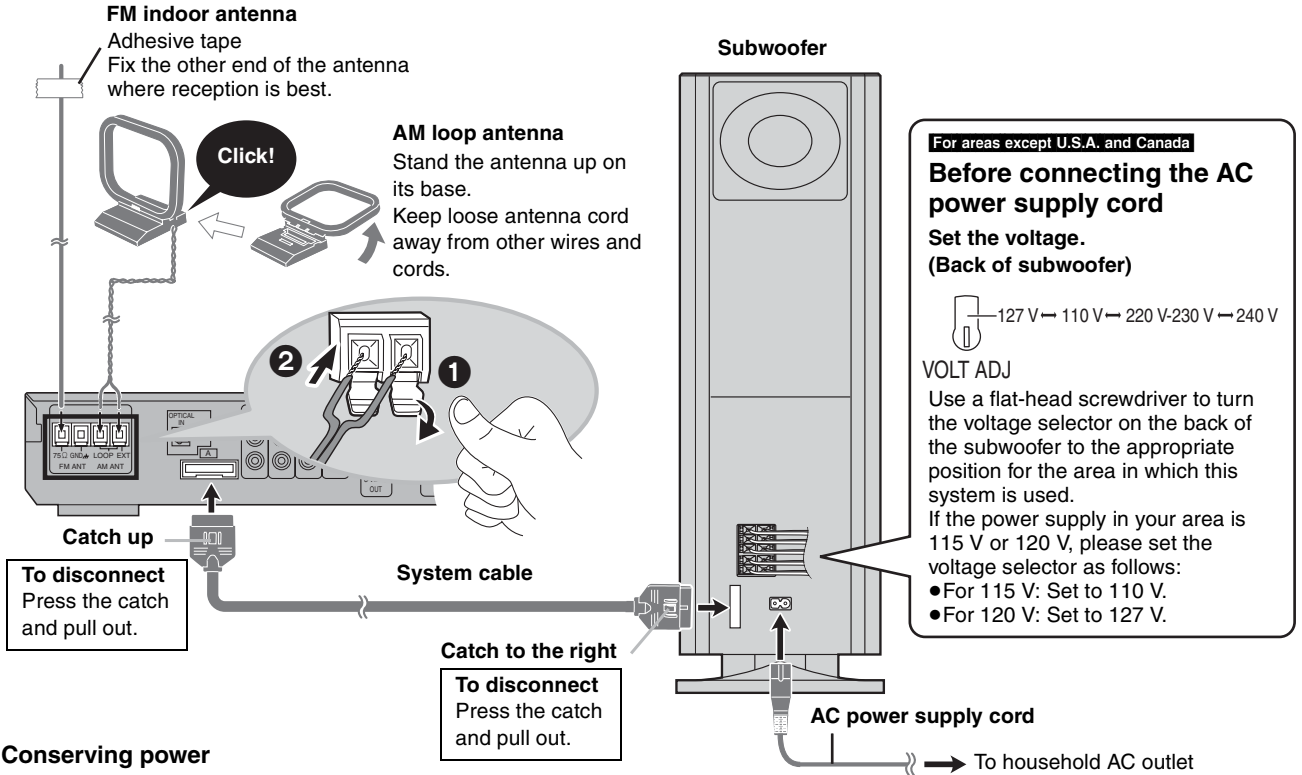

## Conserving power

The unit consumes power (For U.S.A. and Canada: approx. 0.5 W or for units with PX printed on the outer packaging and Latin America: approx. 0.9 W) even when it is turned off with [⏻]. To save power when the unit is not to be used for a long time, unplug it from the household AC outlet. Remember to reset the radio stations and any other memory items before using the unit again.

Information you enter into the unit's memory remains intact for up to 2 weeks after the AC power supply cord is disconnected.

**For areas except U.S.A. and Canada**

**If the power plug will not fit your AC outlet**  
Use the power plug adaptor (included).

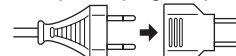

If it still doesn't fit, contact an electrical parts distributor for assistance.

# STEP 5 The remote control

Remote control

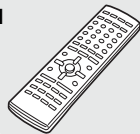

Batteries

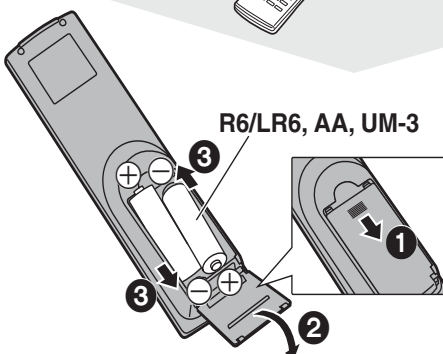

- Insert so the poles (+ and -) match those in the remote control.
- Do not use rechargeable type batteries.

## Do not;

- mix old and new batteries.
- use different types at the same time.
- heat or expose to flame.
- take apart or short circuit.
- attempt to recharge alkaline or manganese batteries.
- use batteries if the covering has been peeled off.

Mishandling of batteries can cause electrolyte leakage which can damage items the fluid contacts and may cause a fire.

Remove if the remote control is not going to be used for a long period of time. Store in a cool, dark place.

## Use

Aim at the sensor, avoiding obstacles, at a maximum range of 7 m (23 feet) directly in front of the unit.

# Other speaker setup options

## Attaching to a wall

**HT900** (Center speaker only) **HT700** **HT690**

**Note**

The wall or pillar on which the speakers are to be attached should be capable of supporting 10 kg (22 lb.) per screw.

**Remove the stand. (HT900 only)**

**BEFORE REMOVING THE STAND**

- Take the speaker cable out of the stand's hole if it is threaded through.
- Lay the speaker on a soft cloth.

Unscrew the screw with a Phillips-head screwdriver.

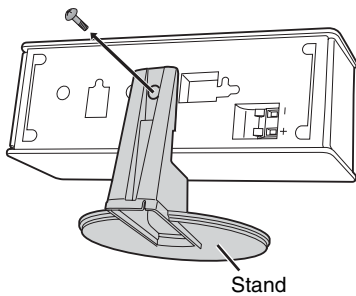

### 1 Screw a screw (not included) into the wall.

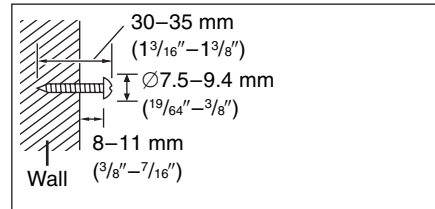

### 2 Fit the speaker securely onto the screw with the hole or holes.

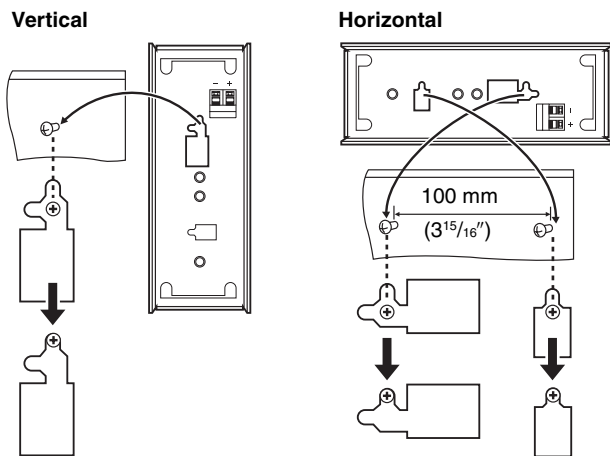

## Fitting speaker stands (optional)

**HT900** (Center speaker only) **HT700** **HT690**

**Preparation**

Remove the stand (**HT900** only).

Ensure the stands meet these conditions before purchasing them.

- Observe the diameter and length of the screws and the distance between screws as shown in the diagram.
- The stands must be able to support over 10 kg (22 lb.).
- The stands must be stable even if the speakers are in a high position.

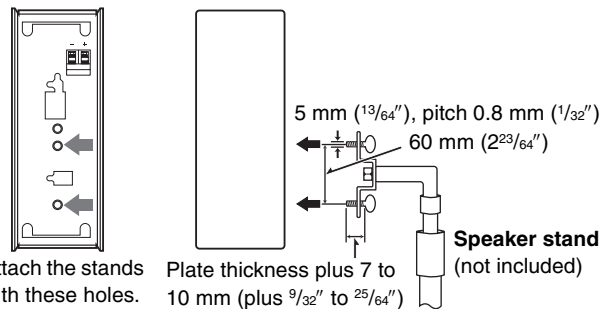

**Notes on speaker use**

- You can damage your speakers and shorten their useful life if you play sound at high levels over extended periods.
- Reduce the volume in the following cases to avoid damage.
  - When playing distorted sound.
  - When the speakers are receiving howling from a record player, noise from FM broadcasts, or continuous signals from an oscillator, test disc, or electronic instrument.
  - When adjusting the sound quality.
  - When turning the unit on or off.

**If irregular coloring occurs on your television**

These speakers are designed to be used close to a television, but the picture may be affected with some televisions and setup combinations.

**If this occurs, turn the television off for about 30 minutes.**

The television's demagnetizing function should correct the problem. If it persists, move the speakers further away from the television.

**Caution**

- Use the speakers only with the recommended system. Failure to do so may lead to damage to the amplifier and/or the speakers, and may result in the risk of fire. Consult a qualified service person if damage has occurred or if you experience a sudden change in performance.
- Do not attempt to attach these speakers to walls using methods other than those described in this manual.

# STEP 6 QUICK SETUP

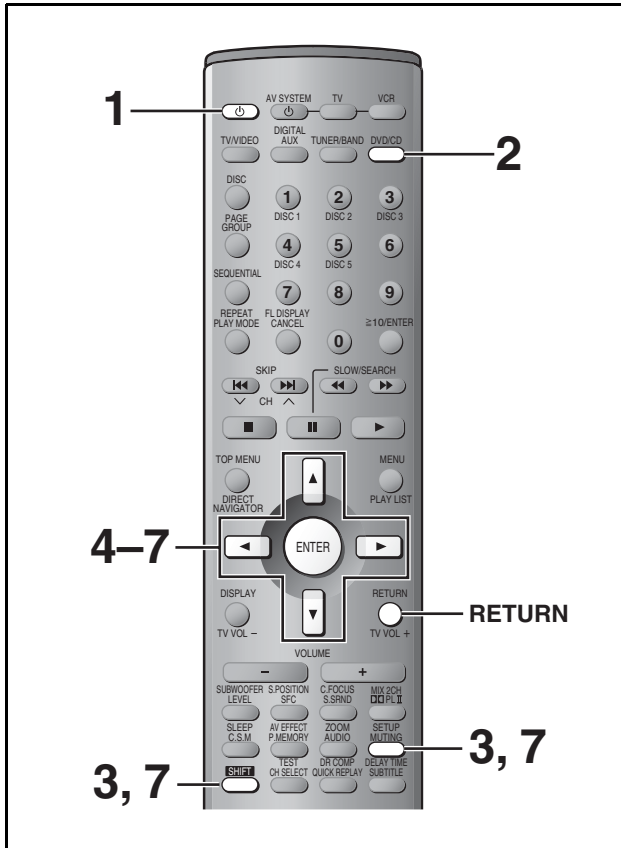

The **QUICK SETUP** screen appears when you press [SHIFT]+[SETUP] the first time after purchase and assists you to make necessary settings. You can access this screen again later if you need to (⇒ page 34, Others—QUICK SETUP).

## Preparation

Turn on the television and select the appropriate video input on the television to suit the connections for the unit.

- 1** Press [⏻] to turn on the unit.
- 2** Press [DVD/CD] to select “DVD/CD” as the source.
- 3** Press [SHIFT]+[SETUP] to show the **QUICK SETUP** screen.

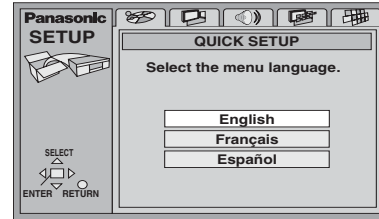

- 4** Press [▲, ▼] to select the menu language and press [ENTER].
- 5** Press [▲, ▼] to select “Yes” to continue and press [ENTER].
- 6** Press [▲, ▼] to select the item and press [ENTER].
  - Audio Language (⇒ page 34)
  - Subtitle Language (⇒ page 34)
  - TV Type (⇒ below)
  - TV Aspect (⇒ below)
- 7** Press [ENTER] and then [SHIFT]+[SETUP] to end the settings.

**To return to the previous screen**  
Press [RETURN].

### ■ TV Type

Select to suit the type of television.

- Standard (Direct View TV) (factory preset)
- CRT Projector
- LCD TV/Projector
- Projection TV
- Plasma TV

### ■ TV Aspect

Select “4:3” (regular) or “16:9” (widescreen) to suit your television.

If you have a regular 4:3 television, you can also select how video on some discs is shown (⇒ page 34, Video—TV Aspect).

- **4:3 Pan&Scan** (factory preset)

Widescreen software is expanded to fill the screen of a 4:3 aspect television (unless prohibited by the producer of the disc).



- **4:3 Letterbox**

Widescreen software is shown in the letterbox style on a 4:3 aspect television.



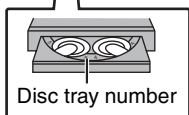
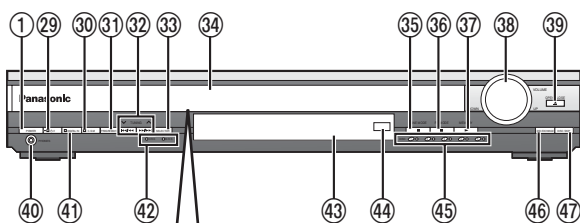
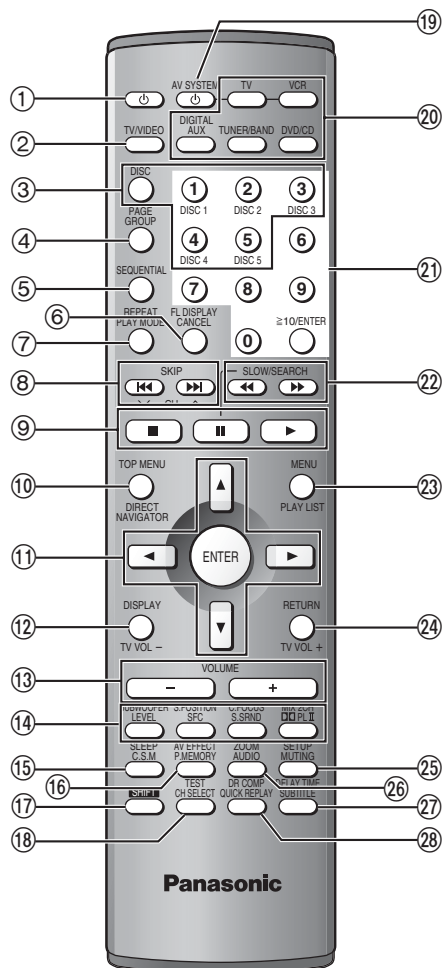

## Remote control

- ① Standby/on switch [⏻] ..... 12
- ② TV/VIDEO button [TV/VIDEO] ..... 32
- ③ Disc select button [DISC], Disc buttons [DISC1]–[DISC5] .. 14
- ④ Group, Page button [GROUP, PAGE] ..... 16, 17
- ⑤ Sequential button [SEQUENTIAL] ..... 15
- ⑥ Cancel, FL display button [CANCEL, FL DISPLAY] .... 19, 31
- ⑦ Play mode, Repeat button [PLAY MODE, REPEAT] ..... 17, 19
- ⑧ Skip, Preset channel, TV channel button  
[◀▶], [SKIP, √ CH ^] ..... 16, 27, 32
- ⑨ Basic operation buttons ..... 14
- ⑩ Top menu, Direct navigator button  
[TOP MENU, DIRECT NAVIGATOR] ..... 14, 21
- ⑪ Cursor buttons [▲, ▼, ◀, ▶], Enter button [ENTER] ..... 12
- ⑫ Display, TV volume down button [DISPLAY, TV VOL–] .. 24, 32
- ⑬ Volume buttons [–, +, VOLUME] ..... 14
- ⑭ Sound field, sound quality buttons ..... 28–31
- HT900 Dolby Pro Logic II button [DOLBII]
- HT700 HT690 Dolby Pro Logic button [DOLPL]
- ⑮ Custom sound memory, Sleep button [C.S.M, SLEEP] .. 30, 31
- ⑯ HT900 Position memory, AV effect button  
[P.MEMORY, AV EFFECT] ..... 15, 29
- HT700 HT690 Position memory button [POSITION MEMORY] .. 15
- ⑰ Shift button [SHIFT]  
To use functions labeled in orange:  
While pressing [SHIFT], press the corresponding button.
- ⑱ Channel select, Test button [CH SELECT, TEST] ..... 28, 29
- ⑲ AV system standby/on button [⏻, AV SYSTEM] ..... 32
- ⑳ Source select buttons  
Face towards this unit to change the source.  
Press [TV] or [VCR] first to operate a Panasonic television or  
video cassette recorder (⇒ pages 32, 33).
- HT900 AUX, DIGITAL input button [AUX, DIGITAL]
- HT700 HT690 AUX button [AUX]
- ㉑ Numbered buttons [1–9, 0, ≥10/ENTER] ..... 16
- ㉒ Slow/search, Tuning buttons  
[◀▶ SLOW/SEARCH] ..... 16, 27
- ㉓ Menu, Play list button [MENU, PLAY LIST] ..... 14, 21
- ㉔ Return, TV volume up button [RETURN, TV VOL+] .. 12, 32
- ㉕ Muting, Setup button [MUTING, SETUP] ..... 12, 31
- ㉖ Audio, Zoom button [AUDIO, ZOOM] ..... 18, 20
- ㉗ HT900 Subtitle, Delay time button  
[SUBTITLE, DELAY TIME] ..... 18, 30
- HT700 HT690 Subtitle button [SUBTITLE] ..... 18
- ㉘ HT900 Quick replay, Dynamic range compression button  
[QUICK REPLAY, DR COMP] ..... 15, 31
- HT700 HT690 Quick replay button [QUICK REPLAY] ..... 15

## Main unit

- ① Standby/on switch [⏻/I, POWER] ..... 12  
Press to switch the unit from on to standby mode or vice versa.  
In standby mode, the unit is still consuming a small amount of power.
- ② Standby/on indicator [⏻/I]  
When the unit is connected to the AC mains supply, this indicator  
lights up in standby mode and goes out when the unit is turned on.
- ③ Custom Sound Memory button [C.S.M] ..... 30
- ④ Progressive out button [PROGRESSIVE] ..... 14
- ⑤ Skip/search, Tuning buttons  
[◀▶ SLOW/SEARCH, ▶, TUNING ^] ..... 16, 27
- ⑥ Source select button [SELECTOR]  
HT900 DVD/CD→FM→AM→TV→VCR→AUX→DIGITAL IN  
HT700 HT690 DVD/CD→FM→AM→TV→VCR→AUX
- ⑦ Drawer
- ⑧ Stop, Tune mode button [■, TUNE MODE] ..... 14, 27
- ⑨ Pause, FM mode button [⏸, FM MODE] ..... 14, 27
- ⑩ Play, Memory button [▶, MEMORY] ..... 14, 27
- ⑪ Volume control [VOLUME, DOWN, UP] ..... 14
- ⑫ Drawer open/close button [▲, OPEN/CLOSE] ..... 14
- ⑬ Headphone jack [PHONES] ..... 31
- ⑭ HT900 DIGITAL IN button [DIGITAL IN] ..... 33
- ⑮ Multi rear surround, Virtual rear surround indicators  
[M.R.S, V.R.S] ..... 29
- ⑯ Display
- ⑰ Remote control signal sensor
- ⑱ Disc indicators [DISC 1–5] ..... 14
- ⑲ Disc exchange button [DISC EXCHANGE] ..... 15
- ⑳ Disc skip button [DISC SKIP] ..... 15

## Subwoofer

- ④⑧ AC supply indicator [AC IN]  
This indicator lights when the unit is connected to the AC mains  
supply.

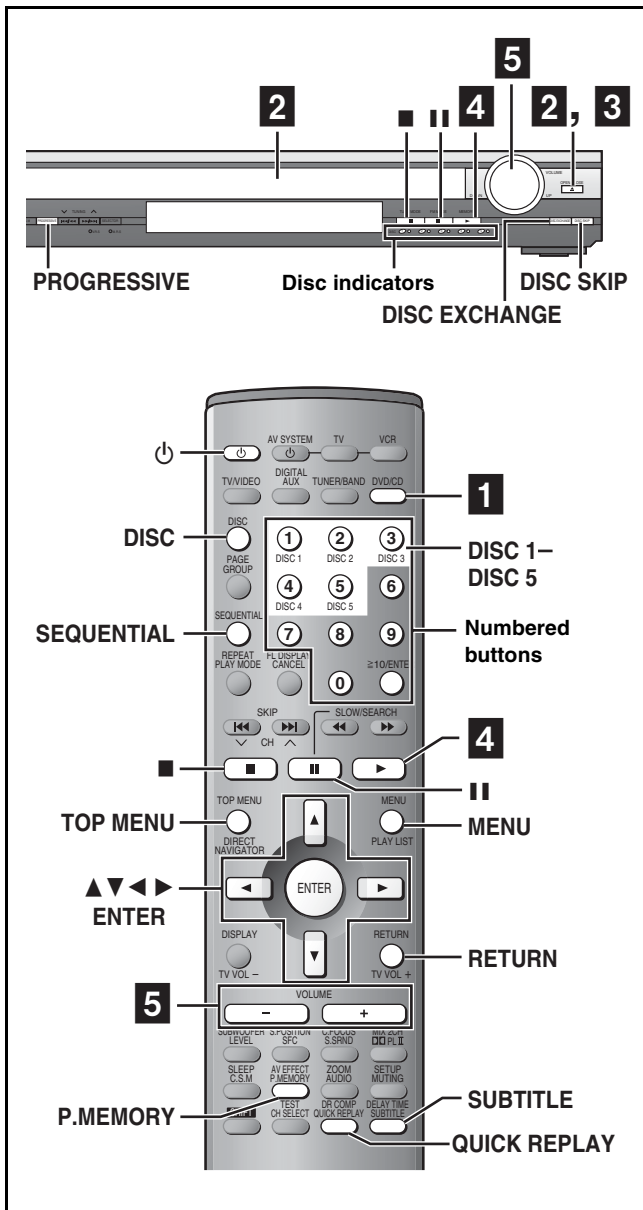

RAM DVD-A DVD-V VCD CD WMA MP3 JPEG

## Preparation

- Press [⏻] to turn on the unit.
- Turn on the television and select the appropriate video input on the television to suit the connections for the unit.

## 1 Press [DVD/CD] to select “DVD/CD” as the source.

### To enjoy progressive video

Press [PROGRESSIVE].

The television will be disrupted for a moment but this is normal.

- Output from this unit is interlace if you have connected to the television through the VIDEO OUT or S-VIDEO OUT or playing PAL discs, even if “PROG.” is on the display.
- When progressive output is on, closed captions will not be displayed.



## 2 Press [▲] to open the drawer and place the disc(s) on the disc tray(s).

To load discs on the other trays, press [DISC SKIP] on the main unit.

If the disc contains both audio data (WMA and MP3) and JPEG, check “Mixed Disc—Audio & Stills” setting in the SETUP menu (→ page 34). Select “Stills (JPEG)” or “Audio (MP3/WMA)”.

- Remove TYPE 2 and 4 discs from their cartridges before use.

Play starts from the disc in the front-left position.

### RAM

- Label-up (With double-sided discs, load so the label for the side you want to play is facing up.)

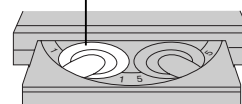

## 3 Press [▲] to close the drawer.

### HT900

A disc indicator lights up red to show a disc is on the tray.

### HT700 HT690

A disc indicator lights up green to show a disc is on the tray.

## 4 Press [▶] (play).

Play begins.

WMA MP3 CD (CD text only)

Group and track names are displayed on the television.

- Press [SUBTITLE] to turn the display on or off.
- You can also use the navigation menus to control play (→ page 22).

## 5 Adjust the volume.

-- dB ◀ 0 dB  
(Minimum) (Maximum)

### To pause play

Press [⏸] during play.

Press [▶] (play) to restart play.

### To stop play

Press [■] (→ page 15, Resume function).

### To select a disc

Press [DISC] and then the disc button ([DISC 1]–[DISC 5]).

### To prevent damage

Do not;

- load more than one disc per tray.
- touch the drawer or the carousel while they are in motion.
- rotate the carousel by hand.
- close the drawer by hand.

### Note

- If “⊘” appears on the television

The operation is prohibited by the unit or disc.

- It may take some time for play to start but this is normal.

### When a menu appears on the television

DVD-A DVD-V VCD

## Press the numbered buttons to select an item.

### To select a 2-digit number

Example: To select item 23, press [≥10] → [2] → [3].

- When playing DVDs, you can also use [▲, ▼, ◀, ▶] to select items. Press [ENTER] to confirm your selection.

### To return to the menu screen

DVD-A DVD-V [TOP MENU]: Shows the first menu screen.

DVD-V [MENU]: Shows the menu screen.

VCD [RETURN]: Shows the menu screen.

### Note

The disc continues to rotate while the menu is displayed even after you finish playing an item. Press [■] when you finish to preserve the unit’s motor and your television screen.

## Sequential play

VCD CD WMA MP3

The unit usually plays the disc in the play position and then stops. Turn sequential play on to play all loaded discs, except for DVDs and JPEG discs.

While stopped

### Press [SEQUENTIAL].

Each time you press the button:

SEQ on ↔ SEQ off



#### Note

- HighMAT menus and video CD playback control are disabled.
- Only audio tracks can be played on HighMAT discs.
- You cannot change the mode during program or random play.
- Sequential Mode turns off when you switch the unit to standby.
- Repeat function does not work when using Sequential Mode.

## Changing the disc in the play position

RAM DVD-A DVD-V VCD CD WMA MP3 JPEG

Main unit only

### 1 Press [DISC EXCHANGE].

The drawer opens and the disc in the play position comes to the front-left position.

### 2 Change the disc in the front-left position.

### 3 Press [DISC EXCHANGE].

The drawer closes.

## Changing other discs during play

RAM DVD-A DVD-V VCD CD WMA MP3 JPEG

You can change the other discs without interrupting play.

Main unit only

### 1 Press [▲] to open the drawer.

### 2 Press [DISC SKIP] to rotate the carousel.

The carousel moves one tray clockwise and each subsequent press moves it two trays in alternate directions.

### 3 Change the disc and press [▲] to close the drawer.

## Position Memory function

RAM DVD-A DVD-V VCD CD WMA MP3 JPEG

During play

### Press [P.MEMORY] (or [POSITION MEMORY]) to memorize a position.

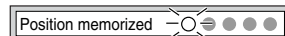

Press again to replace the position.

This position is saved even if you turn the unit off, change the source or change discs. When you turn the unit on, reselect "DVD/CD" or reinsert the disc whose position you memorized, "RESUME" lights on the display. Press [▶] (play) to start play from the memorized position. The position is cleared.

- You can memorize positions on up to five different discs at a time. When you memorize another position, the earliest position is replaced.
- You cannot recall the position in Sequential Mode.

#### Resume function

"RESUME" lights on the display when the unit has recorded the position at which you stopped play.

Press [▶] (play) to start play from that position.

- The position is cleared when you:
  - Turn the unit off.
  - Select another source or change discs.
- Press [■] to clear the position.

#### Chapter Preview

DVD-V

The following message appears immediately after you press [▶] (play) when "RESUME" is displayed.

Press [▶] (play) while the message is displayed and the beginning portions of each chapter up to the current one are played.

Full play resumes from the point where you pressed [■] or [P.MEMORY] (or [POSITION MEMORY]). (This feature works only within a title.)

If you do not press [▶] (play), the message disappears and play starts from where you pressed [■] or [P.MEMORY] (or [POSITION MEMORY]).

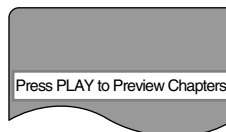

## Replaying a scene—QUICK REPLAY

RAM DVD-A DVD-V VCD CD WMA MP3

Skip back a few seconds within the current item (program, track or title).

JPEG

Skip back a few pictures.

During play

### Press [QUICK REPLAY].

#### Note

This feature may not work while playing some parts of a disc or at all with some discs.

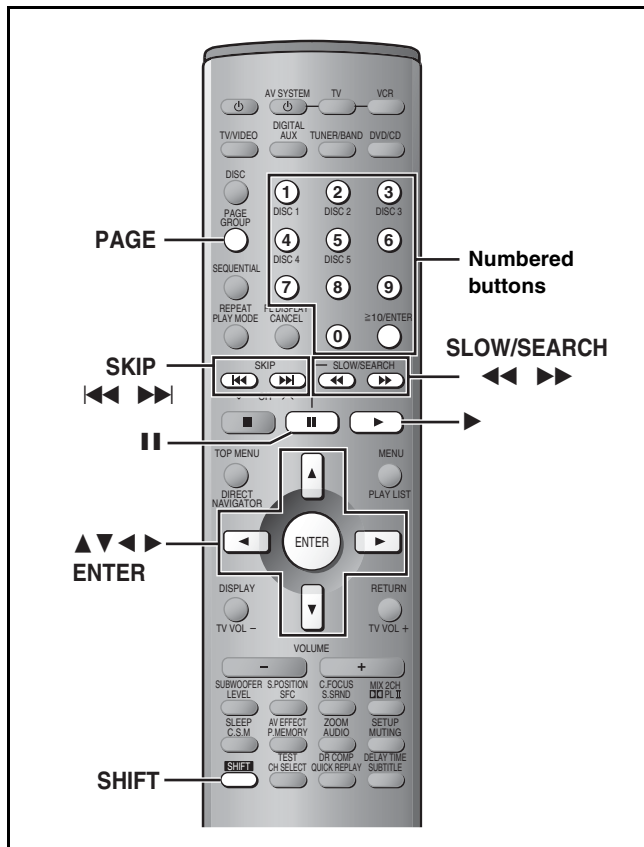

## Starting play from a selected item

RAM DVD-A DVD-V VCD CD WMA MP3 JPEG

Press the numbered buttons to select the item.

Play starts from the selected item.

To select a 2-digit number

Example: To select track 23, press  $\geq 10$  → [2] → [3].

WMA MP3 JPEG [2] → [3] → [ENTER]

### Note

- This works only when stopped with some discs.
- When playing DVD-Audio and you want to start play from a track in a different group, select the group first (→ page 17).

## Selecting still pictures—Page Skip

DVD-A

During play or while paused

Press [SHIFT]+[PAGE].

The page changes each time you press the button.

PAGE 1

## Skipping items

RAM DVD-A DVD-V VCD CD WMA MP3

During play or while paused

Press [ $\lll$ ] or [ $\ggg$ ].

- Press [ $\lll/\lll$ ] or [ $\ggg/\ggg$ ] on the main unit.

JPEG

Press [ $\ll$ ] or [ $\gg$ ] for picture skip, or [ $\blacktriangle$ ] or [ $\blacktriangledown$ ] for group skip.

- Each press increases the number of skips.

Example RAM

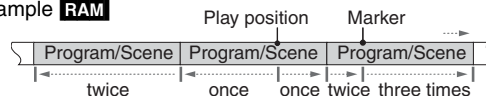

## Fast forward and rewind—SEARCH

RAM DVD-A DVD-V VCD CD WMA MP3

During play

Press [ $\lll$ ] or [ $\ggg$ ].

- Press and hold [ $\lll/\lll$ ] or [ $\ggg/\ggg$ ] on the main unit.
- Audio will be heard during search for most discs. You can turn this audio off if you want to (→ page 34, Audio—Audio during Search).
- DVD-V You can slow down or speed up play (→ page 24).

## Slow-motion play

RAM DVD-V VCD

DVD-A (Motion picture parts only)

While paused

Press [ $\lll$ ] or [ $\ggg$ ].

- Press and hold [ $\lll/\lll$ ] or [ $\ggg/\ggg$ ] on the main unit.

## Frame-by-frame viewing

RAM DVD-V VCD

DVD-A (Motion picture parts only)

While paused

Press [ $\ll$ ] or [ $\gg$ ].

The frame changes each time you press the button.

- The frames change in succession if you press and hold the button.
- Pressing [II] also activates forward frame-by-frame.

### Notes

- The speed of search and slow-motion increases up to 5 steps.
- Press [ $\gg$ ] (play) to restart play.
- You cannot move backwards with Video CD during frame-by-frame and slow-motion.

### When playing Video CDs with playback control

Pressing buttons to perform skip, search or slow-motion may take you to a menu screen.



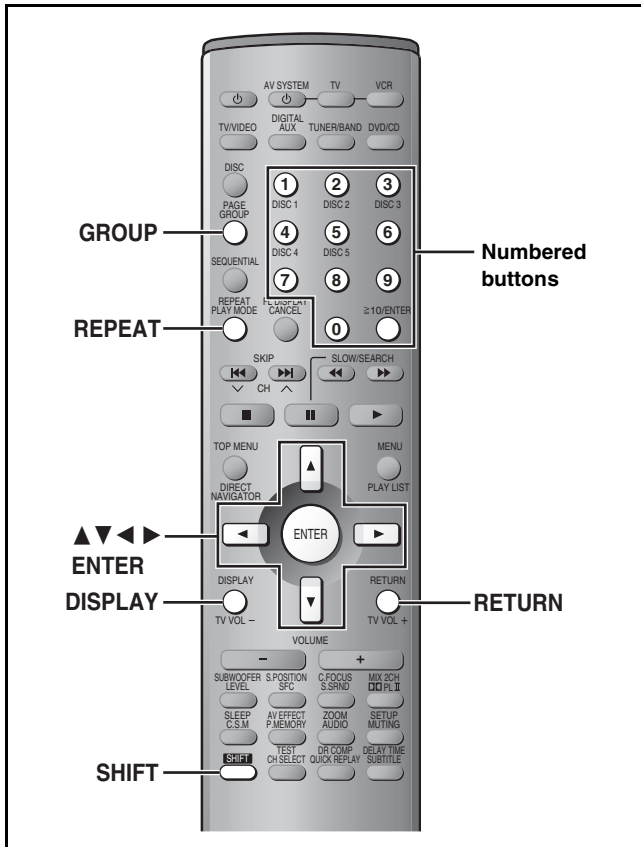

## Selecting groups to play

**DVD-A** **WMA** **MP3** **JPEG**

**1** Press **[GROUP]**.

Example **MP3**



Track number in group  
Group number

**2** Press the numbered buttons to select the group and press **[ENTER]**.

**3** Press the numbered buttons to select the track/picture number and press **[ENTER]**.

**DVD-A**

Playing all the groups in succession (⇒ Page 19, All group play)

Playing bonus groups

Some discs contain bonus groups. If a password screen appears after selecting a group, enter the password with the numbered buttons. Refer also to the disc's jacket.

## Repeat play

**RAM** **DVD-A** **DVD-V** **JPEG**

**VCD** **CD** **WMA** **MP3** (There is no on-screen display.)

During play

Press **[SHIFT]+[REPEAT]**.

Each time you press the button:

**RAM**

PG REPEAT → ALL REPEAT (Entire disc) → REPEAT OFF

• During play list play

SCENE REPEAT → PL REPEAT → REPEAT OFF

**DVD-V**

CHAPTER REPEAT → TITLE REPEAT\* → REPEAT OFF

**VCD** **CD**

TRACK REPEAT → ALL REPEAT (Entire disc) → REPEAT OFF

**DVD-A** **WMA** **MP3**

TRACK REPEAT → GROUP REPEAT\* → REPEAT OFF

**JPEG**

GROUP REPEAT → REPEAT OFF

※ During all group (**DVD-A**), program and random play

“ALL REPEAT” is displayed.

• You can also repeat play of content and group on HighMAT discs.

## To repeat only your favorite tracks/chapters

Start program play (⇒ page 19) and press **[SHIFT]+[REPEAT]** to select the repeat mode.

## A-B repeat play

**RAM** **DVD-A** **DVD-V** **VCD** **CD** **WMA** **MP3**

You can repeat a section between points A and B within a program, title or track.

**1** During play

Press **[DISPLAY]** until the unit information screen is displayed

(⇒ page 25).

**2** Press **[▲, ▼]** to select the play menu.

Example **DVD-V**



A-B Repeat

**3** Press **[◀, ▶]** to select “A-B Repeat” and

① Press **[ENTER]** at the starting point (A).

② Press **[ENTER]** at the finishing point (B).



A-B repeat starts.

To return to the normal play

Press **[ENTER]** again.

To clear the menus

Press **[RETURN]** until the menu disappears.

**Note**

A-B repeat is canceled when you press **[QUICK REPLAY]**.

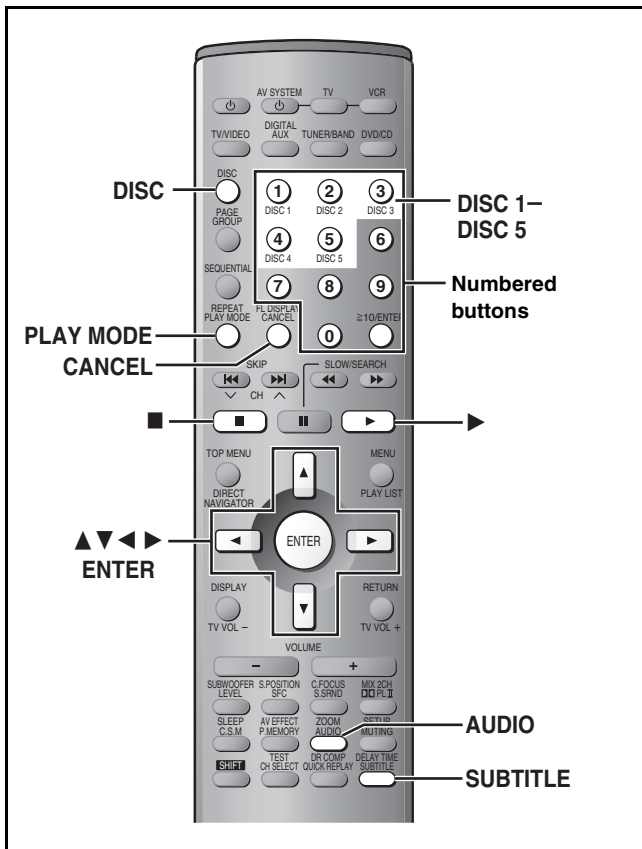

- “-” or “-” is displayed instead of the language number in circumstances such as when no language is recorded on the disc.
- VCD** (SVCD only)  
 Soundtrack and subtitle numbers may change even if corresponding soundtracks are not recorded.

## Soundtracks

**RAM DVD-A DVD-V VCD**  
 (Discs with multiple soundtracks)

**During play**  
 Press **[AUDIO]**.

The number changes each time you press the button.

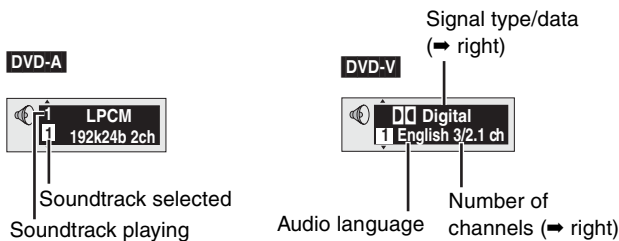

**RAM VCD**

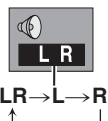

- You can also use this button to turn the vocals on and off on karaoke discs. Read the disc's instructions for details.
- DVD-A**
- Play restarts from the beginning of the soundtrack when changing soundtracks that are accompanied by still pictures.
  - Even if a second soundtrack isn't recorded, two soundtrack numbers will normally be shown when you press **[AUDIO]**. The soundtrack currently playing is number 1.

## Signal type/data

LPCM/PPCM/□□ Digital/DTS: Signal type  
 k (kHz): Sampling frequency  
 b (bit): Number of bits ch (channel): Number of channels

Example:  
 3/2\_1ch

- .1: Low frequency effect (not displayed if there is no signal)
- 0: No surround
- 1: Mono surround
- 2: Stereo surround (left/right)
- 1: Center
- 2: Front left+Front right
- 3: Front left+Front right+Center

## Subtitles

**DVD-A** (Motion picture parts only)

**DVD-V VCD** (SVCD only)

You can change the subtitle language and turn the subtitles on and off.

**RAM**

You can turn the subtitles on and off.

**During play**

Press **[SUBTITLE]**.

The number changes each time you press the button.

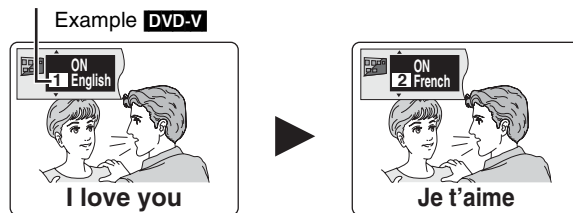

- In some cases, the subtitle language is not changed to the selected one immediately.
- If the subtitles overlap closed captions recorded on discs, turn the subtitles off.

**To clear/display the subtitles**

- 1 Press **[SUBTITLE]**.
- 2 Press **[▶]**. (**DVD-A DVD-V VCD**)
- 3 Press **[▲, ▼]** to select “OFF” or “ON”.

■ **Changing the position and brightness of the subtitles (⇒ page 26)**

DVD-A DVD-V VCD CD WMA MP3

### Common procedures for all group, program and random play

#### While stopped

Press [PLAY MODE].

Each time you press the button:

DVD-A DVD-V WMA MP3

All group (DVD-A) → Program → Random → off (Normal play)

VCD CD

(PGM) → 1-DISC (RND) → ALL-DISC (RND) → off (Normal play)

DVD-A

If you select bonus groups, you will have to enter a password (→ page 17).

### All group play

DVD-A

The unit plays tracks in all the groups on a disc.

Press [▶] (play).

### Program play

You can select up to 24 items to play in the order you choose.

VCD CD (There is no on-screen display.)

You can program all the items on discs.

DVD-A DVD-V WMA MP3

You can program all the items on a disc in the play position.

Example DVD-V

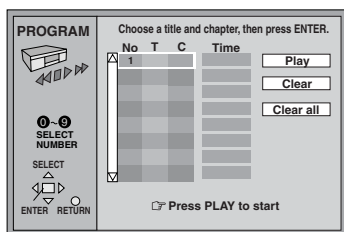

1 VCD CD

Press the [DISC] and then the disc button ([DISC 1]–[DISC 5]).

2 Press the numbered buttons to select a title, chapter, group or track (WMA MP3 then press [ENTER]).

Example CD

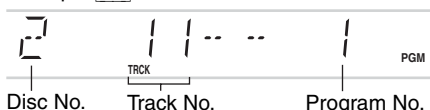

• **To select a 2-digit number**

Example: To select item 25, press [≥10] → [2] → [5].

WMA MP3 [2] → [5] → [ENTER]

• Repeat this step to program other items.

• VCD CD

Step 1 is unnecessary when programming tracks on the same disc.

**Note**

Disable HighMAT disc play to use random and program play.

In the SETUP menu, set "HighMAT" to "Disable" (→ page 34) and perform the necessary operations (→ above).

• DVD-A DVD-V WMA MP3

**To select an item using the cursor buttons**

Press [ENTER] and [▲, ▼] to select an item, then press [ENTER] again to register the number.

All the items in the selected disc, title or group are selected when you select "ALL".

## 3 Press [▶] (play).

#### To add or change the program

VCD CD (Add only)

Repeat steps 1 and 2.

DVD-A DVD-V WMA MP3

Press [▲, ▼] to select an available item, then repeat step 2.

#### To clear an item

VCD CD

Press [CANCEL].

DVD-A DVD-V WMA MP3

1 Select the item you want to clear with [▲, ▼].

2 Press [CANCEL], or select "Clear" with [▲, ▼, ◀, ▶] and press [ENTER].

#### To clear the whole program

VCD CD

Press [■] so "CLEAR" is displayed.

DVD-A DVD-V WMA MP3

Select "Clear all" with [▲, ▼, ◀, ▶] and press [ENTER].

**Note**

• DVD-V WMA MP3

Times are not displayed while programming.

• VCD CD

Items the unit cannot find can be programmed but are canceled during play. This is also the case if you program DVD-RAM, DVD-Audio, DVD-Video, WMA, MP3 and JPEG.

• The program is cleared when you switch the unit to standby, select another source, exit the program mode by pressing [PLAY MODE] or move the disc out of the play position.

VCD CD

The program is retained in memory.

### Random play

VCD CD (There is no on-screen display.)

1-DISC (RND): You can play a disc in the play position in random order.

ALL-DISC (RND): You can play all discs in random order.

DVD-A DVD-V WMA MP3

You can play items on a disc in the play position in random order.

1 DVD-A DVD-V

Press the numbered buttons to select a title or a group.

Example DVD-V



DVD-A

• You can select more than one group.

• To enter all groups, select "All" using [◀, ▶] and press [ENTER].

• To deselect a group, press the numbered buttons corresponding to the group you want to clear.

## 2 Press [▶] (play).

**Note**

During random play, empty trays are skipped and the playback control function on Video CDs is canceled.

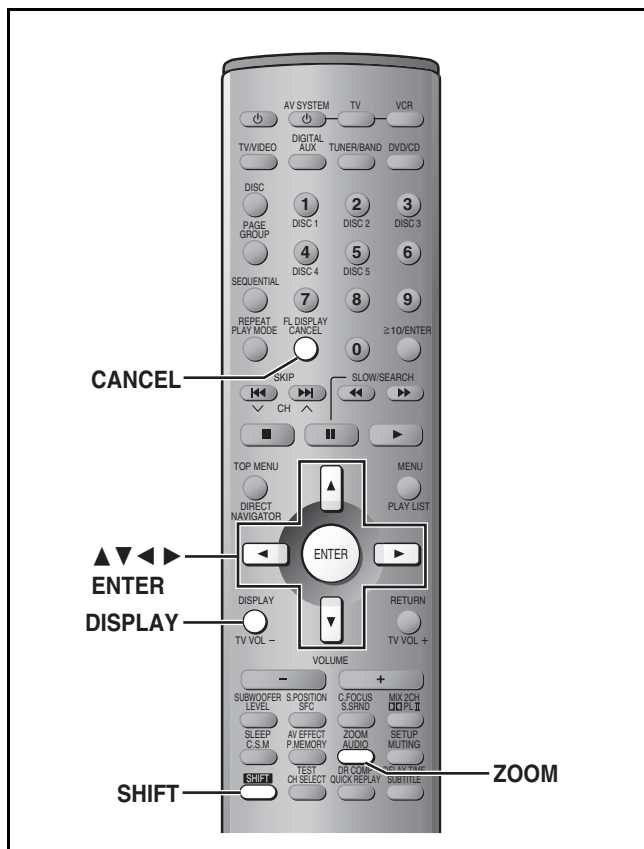

## Marking places to play again

RAM DVD-A DVD-V VCD CD WMA MP3 JPEG

You can mark a position so you can return to it easily at a later time.

- During play**

Press **[DISPLAY]** until the unit information screen is displayed (→ page 25).
- Press **[▲, ▼]** to select the play menu.

Example **DVD-V**



Marker
- Press **[◀, ▶]** to select “Marker” and press **[ENTER]**.

**RAM**

Press **[▶]** to select an asterisk (\*).
- Press **[ENTER]** at the point you want to mark.

### To mark another position

Up to 5 points (**RAM** only: up to 999 points)

- Press **[▶]** to select “\*”.
- Press **[ENTER]** at the point.

### To recall or erase a marker

- Press **[◀, ▶]** to select a marker.
- Press **[ENTER]** to recall or press **[CANCEL]** to erase.

### RAM

#### To mark the eleventh point and beyond

- Press **[◀, ▶]** to select the marker pin icon.

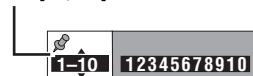

- Press **[▲, ▼]** to select “11–20”.

You can select the next group when the current group is full.

### Note

Markers added with this unit clear when you switch the unit to standby, change the source, or change the disc.

## Variable Zoom function

RAM DVD-V VCD

DVD-A (Motion picture parts only)

Change the zoom ratio so the picture expands to the optimum size to fill the screen.

### Preparation

Change the setting “TV Aspect” to suit your television (→ page 34).

### During play

Press **[SHIFT]+[ZOOM]** to select the aspect ratio.

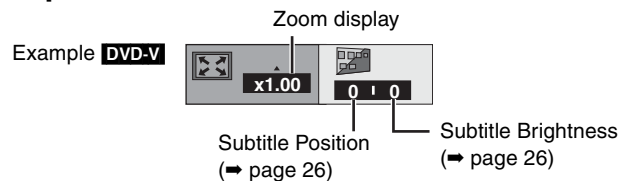

Each time you press the button:

**4:3 Standard** → **European Vista** → **16:9 Standard**

**Cinemascope2** ← **Cinemascope1** ← **American Vista**

- Refer to the disc’s instructions and “Screen size” below for the aspect ratio of the picture.

### To restore the original ratio

Press **[SHIFT]+[ZOOM]** until the ratio returns to 1.00.

- The ratio also returns to 1.00 when you change the disc, change the source or switch the unit to standby.
- The ratio may return to 1.00 when a menu is displayed.

### Making fine adjustments to the zoom ratio

While the ZOOM icon is displayed

Press **[▲, ▼]**.

The ratio changes in 0.01 units between 1.00 and 1.60 and in 0.02 units between 1.60 and 2.00.

### Screen size

Movies are made using a variety of screen sizes.

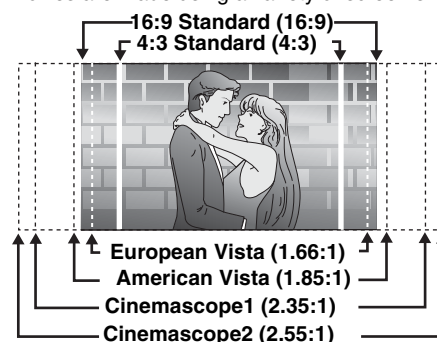

## Using the play list menu

You can play a group of scenes, a play list, created on other equipment such as a DVD video recorder.

### 1 Press [PLAY LIST].

No	Date	Length	Title
1	10/17	0:46:35	Clay Penguin
2	10/24	0:09:15	Ashley at Prom
3	11/29	0:12:32	Formula one
4	12/22	0:07:30	Soccer
5	12/23	0:30:20	Baseball
6	12/23	0:08:15	Neanderthal
7	12/24	0:15:30	Cartoons
8	12/24	0:20:30	Trilobites
9	12/25	0:20:00	White Dwarf
10	12/25	0:55:00	Discovery

### 2 Press [▲, ▼] to select the play list.

• You can select play lists with the numbered buttons.

**To select a 2-digit number**

Example 23: [≧10] → [2] → [3]

### 3 Press [ENTER] to start play.

**To clear the play list screen**

Press [PLAY LIST].

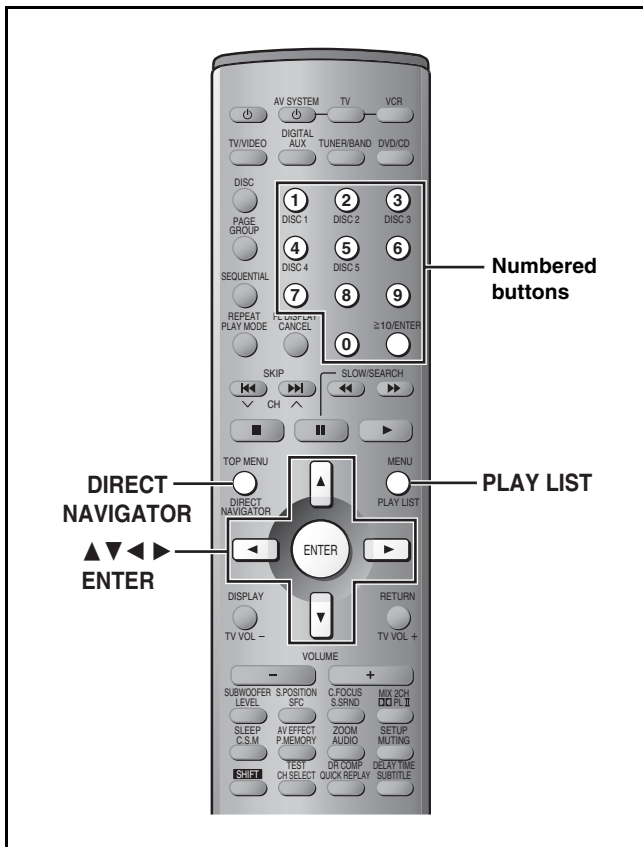

## RAM

### Selecting a program to play—DIRECT NAVIGATOR

Use the program list to find programs to play.

### 1 Press [DIRECT NAVIGATOR].

No	Date	On	Program Title
1	11/11(MON)	11:02PM	Monday feature
2	11/12(TUE)	10:35PM	Auto action
3	11/12(TUE)	10:00PM	Cinema
4	11/14(TH)	9:30PM	Music
5	11/14(TH)	8:05PM	Baseball

### 2 Press [▲, ▼] to select the program.

The selected program plays in the background.

• You can select programs with the numbered buttons.

**To select a 2-digit number**

Example 23: [≧10] → [2] → [3]

### 3 Press [ENTER].

The program being played in the background continues.

**To clear the program list**

Press [DIRECT NAVIGATOR].

## Note

- Titles appear only if you have entered them.
- You cannot change program and disc titles.

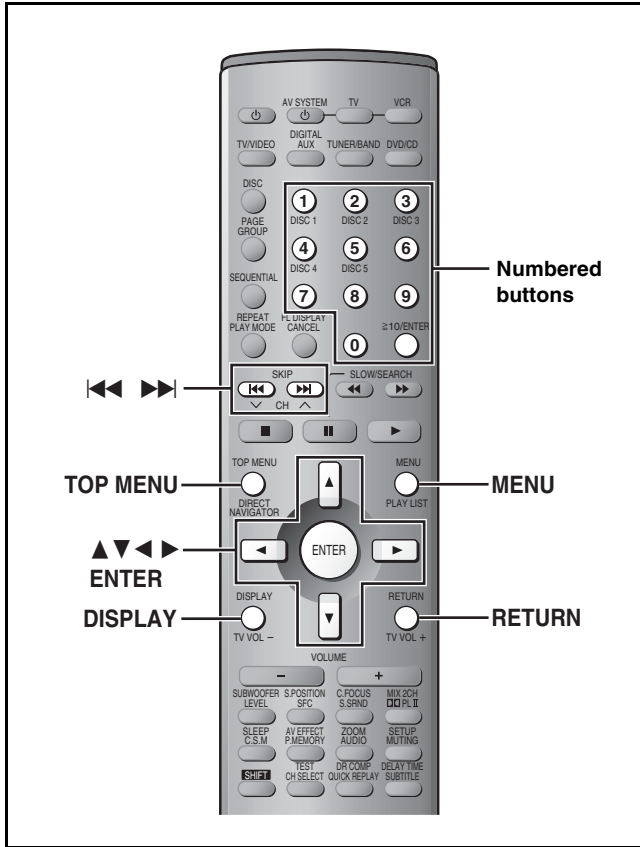

Track title search **WMA** **MP3** **CD** (CD text only)

Example: finding a track including the word "LOVE"

- 1 While the menu is displayed  
Press [**▲**, **▼**] to select "Find" and press [**ENTER**].

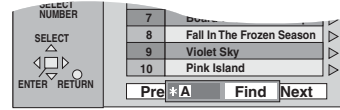

- 2 Press [**▲**, **▼**] to select "L" and press [**ENTER**].

Characters change in alphanumeric order each time you press [**▲**].

Repeat this step to enter "O", "V", and "E".

• Press [**◀**, **▶**] to skip between A, E, I, O, and U.

• Only uppercase appear but the search also includes lower case.

• Press [**◀**] to erase a character.

• You can erase the asterisk (\*) to search for the first word in a title.

• You can enter numbers with the numbered buttons.

- 3 Press [**▶**] to select "Find" and press [**ENTER**].

The search results screen appears.

- 4 Press [**▲**, **▼**] to select the track and press [**ENTER**].

If the disc contains both audio data (WMA and MP3) and JPEG, check "Mixed Disc—Audio & Stills" setting in the SETUP menu (➔ page 34). Select "Stills (JPEG)" or "Audio (MP3/WMA)".

**WMA** **MP3** **CD** (CD text only) **JPEG**

Various menus help you find items you want to start play.

- 1 Press [**TOP MENU**].

**WMA** **MP3** Audio navigation menu

**JPEG** Album display

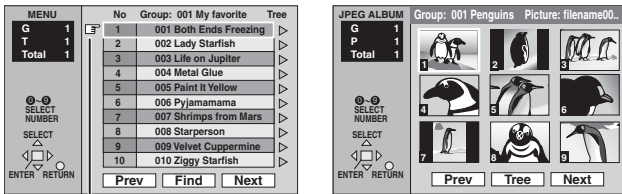

"G" indicates the track currently playing.

- 2 Press [**▲**, **▼**] to select a track or [**▲**, **▼**, **◀**, **▶**] to select a picture, and press [**ENTER**].

To show other pages, press [**▲**, **▼**, **◀**, **▶**] to select "Prev" or "Next" and press [**ENTER**].

• After listing all the tracks or pictures in one group, the list for the next group appears.

To exit to the menu

Press [**TOP MENU**].

To use the tree screen to find a group **WMA** **MP3** **JPEG**

- 1 While the menu is displayed  
**WMA** **MP3**  
Press **[▶]** while a track is highlighted to display a tree screen.

**JPEG**

Press **[▲, ▼, ◀, ▶]** to select "Tree" and press **[ENTER]**.

Example **MP3**

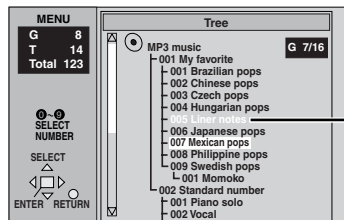

You cannot select groups that contain no compatible files.

- 2 Press **[▲, ▼, ◀, ▶]** to select a group and press **[ENTER]**.

The audio navigation menu/album display for the group appears.

To return to the menu  
Press **[RETURN]**.

To use the contents screen to find a track  
**CD** (CD text only)

You can use the text information recorded on these discs to find a track to play.

- 1 While the menu is displayed  
Press **[▶]** while a track is highlighted to display the contents screen.

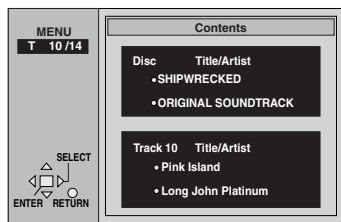

- 2 Press **[◀, ▶]** to move through the tracks and press **[ENTER]**.

To return to the menu  
Press **[RETURN]**.

See page 37 for details about WMA, MP3, CD text and JPEG.

## Playing HighMAT discs

A menu appears when you select the disc.

Press **[▲, ▼, ◀, ▶]** to select then press **[ENTER]**.

When you press **[ENTER]**:



Menu: Takes you to the next menu which shows play lists or another menu



Play list: play starts

- To return to the menu screen  
Press **[TOP MENU]**.
- To return to the menu above the current one  
Press **[RETURN]**.
- To change the menu background  
Press **[DISPLAY]**.  
The background changes to the one recorded on the disc.

### Selecting from the lists

- 1 During playing

Press **[MENU]**.

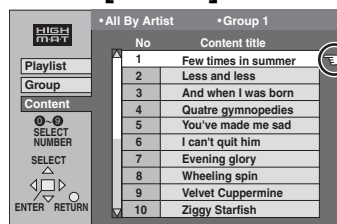

- 2 Press **[◀]** then **[▲, ▼]** to switch between the play list, group and content lists.
- 3 Press **[▶]** then **[▲, ▼]** to select an item and press **[ENTER]**.

To exit the list screen  
Press **[MENU]**.



HighMAT and the HighMAT logo are either trademarks or registered trademarks of Microsoft Corporation in the United States and/or other countries.

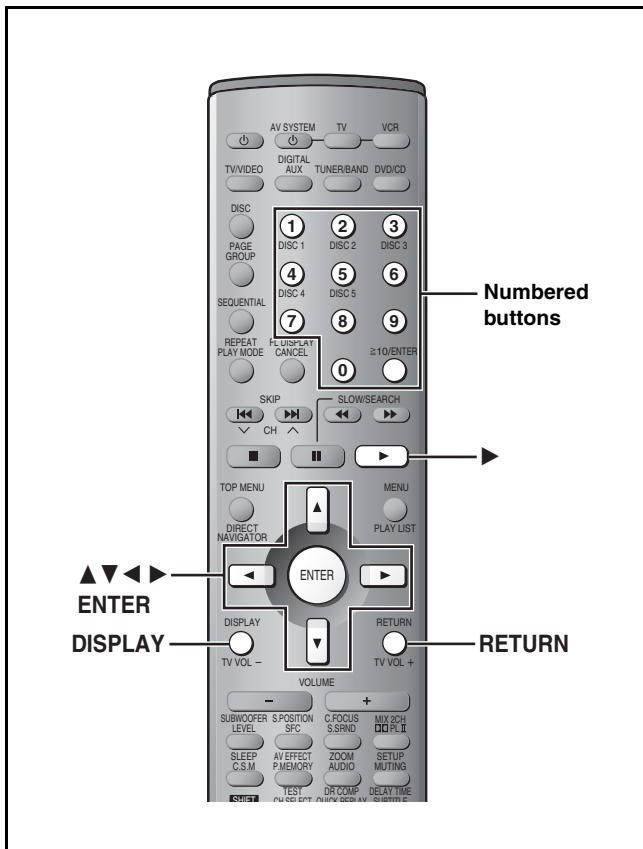

RAM DVD-A DVD-V VCD CD WMA MP3 JPEG

On-Screen Menu Icons are menus that contain information about the disc or unit. These menus allow you to perform operations by changing this information.

## Common procedures

### 1 Press [DISPLAY].

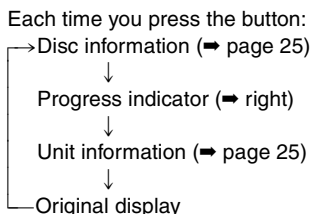

### 2 Unit information only

While the leftmost icon is highlighted  
Press [▲, ▼] to select the menu.

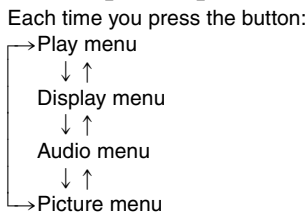

### 3 Press [◀, ▶] to select the item.

### 4 Press [▲, ▼] to select the setting.

- Items with “▲” or “▼” above and below can be changed by [▲, ▼].
- Press [ENTER] if the setting does not change after pressing [▲, ▼].
- Some items require different operations. Read the explanations on the following pages.

#### For your reference

- Depending on the condition of the unit (playing, stopped, etc.) and the type of software you are playing, there are some items that you cannot select or change.
- When numbers are displayed (e.g. title No.), the numbered buttons are also effective for setting. After entering the numbers, press [ENTER] to register the setting.

#### To clear the menus

Press [RETURN] until the menus disappear.

#### ■ To change the position of the icons

- 1 Press [◀, ▶] to select the rightmost icon.
- 2 Press [▲, ▼] to move the icons. (There are 5 positions.)

## Progress indicator

Indicates how far you have played through an item.  
Example **DVD-V**

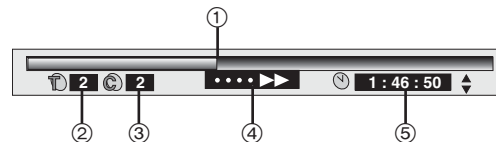

- ① **Current position** RAM DVD-A DVD-V VCD CD WMA MP3
- ② **PG: Program number** RAM  
**PL: Play list number** RAM  
**T: Title number** DVD-V  
**Track number** VCD CD  
**G: Group number** DVD-A WMA MP3 JPEG
- ③ **T: Track number in group** DVD-A WMA MP3  
**C: Chapter number** DVD-V  
**P: Picture number** JPEG
- ④ **Condition-play, pause, or slow/search**  
RAM DVD-A DVD-V VCD CD WMA MP3  
Play speed (→ below)
- ⑤ **Changing the time display** RAM DVD-A DVD-V VCD CD  
Press [▲, ▼] to show the elapsed play time or remaining time for the program, play list, track or title (or chapter during program and random play).  
**Elapsed play time** VCD (SVCD only) WMA MP3  
(display only, cannot be changed)

### Changing play speed

**DVD-A** (Motion picture part only)  
**DVD-V** (Dolby Digital only)  
You can slow down or speed up play.

During play  
Press [◀] (slower) or [▶] (faster).

There are five speeds:  
×0.8 ↔ ×0.9 ↔ ×1.0 (normal speed) ↔ ×1.2 ↔ ×1.4

After you change the speed, output is in stereo.  
Sound is stereo as long as “×1.0” is orange.  
To return to normal play (surround sound), press [▶] (play) or [ENTER].  
Normal play is also restored when you return the speed to ×1.0 and clear the progress indicator.



Unless otherwise indicated, select items with [◀, ▶] and change with [▲, ▼].

## Disc information

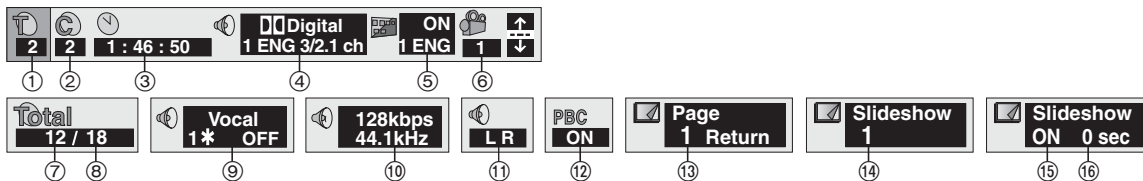

①	PG: Program number <b>RAM</b> PL: Play list number <b>RAM</b> G: Group number <b>DVD-A WMA MP3 JPEG</b> T: Title number <b>DVD-V</b> Track number <b>VCD CD</b>	[▲, ▼] ↓ [ENTER]
②	T: Track number in group <b>DVD-A WMA MP3</b> C: Chapter number <b>DVD-V</b> P: Picture number <b>JPEG</b>	[ENTER]
③	<b>Time RAM DVD-A DVD-V</b> Select a position to start play by specifying a time.  <b>Changing the time display</b> <b>RAM DVD-A DVD-V VCD CD</b> [VCD (SVCD only) WMA MP3 Display only] →Elapsed play time for the program, play list, title or track ↓ ↑ Remaining time for the group ( <b>DVD-A</b> ) or disc ( <b>VCD CD</b> ) ↓ ↑ Remaining time for the program, play list, title or track	Numbered buttons ↓ [ENTER]
④	<b>Soundtrack DVD-A DVD-V</b> (⇒ page 18) Refer to “Audio/Subtitle language” (⇒ right) for language abbreviations.	
⑤	<b>Subtitle language DVD-A DVD-V VCD</b> (SVCD only) (⇒ page 18) Refer to “Audio/Subtitle language” (⇒ right) for language abbreviations. <b>Subtitles on/off RAM DVD-A DVD-V VCD</b> (SVCD only) <b>Track information on/off WMA MP3 CD</b> (CD text only) <b>Picture data JPEG</b> Full: Group title, picture title, picture size, file size, date of shooting, and camera model used.* Date: Date of shooting only. OFF: No display *Displays differ depending on the type of camera and condition of the data.	

⑥	<b>Angle number DVD-A DVD-V</b> <b>Picture rotation JPEG</b> 0↔90↔180↔270 ↑	
⑦	<b>Track/picture number in disc</b> <b>WMA MP3 JPEG</b>	[▲, ▼] ↓ [ENTER]
⑧	<b>Total number of tracks/pictures on disc</b> <b>WMA MP3 JPEG</b>	Display only
⑨	<b>Karaoke vocal on/off DVD-V</b> (Karaoke DVD only) If a DVD title is a duet, select V1 or V2 to duet with the unit.	
⑩	<b>Current bitrate (kbps)</b> <b>Current sampling frequency (kHz)</b> <b>WMA MP3</b>	Display only
⑪	<b>Audio mode RAM VCD</b> LR↔L↔R ↑	
⑫	<b>Menu play</b> <b>VCD</b> (with playback control only)	Display only
⑬	<b>Still picture number DVD-A</b> •To return to page 1 [◀, ▶]→Select “Return”→[ENTER]	
⑭	<b>Slideshow DVD-A</b> Picture number	Display only
⑮	<b>Slideshow setting JPEG</b> ON↔OFF	
⑯	<b>Slideshow timing JPEG</b> 0 sec–30 sec	

### Audio/Subtitle language

ENG: English	SVE: Swedish	CHI: Chinese
FRA: French	NOR: Norwegian	KOR: Korean
DEU: German	DAN: Danish	MAL: Malay
ITA: Italian	POR: Portuguese	VIE: Vietnamese
ESP: Spanish	RUS: Russian	THA: Thai
NLD: Dutch	JPN: Japanese	*: Others

## Unit information

### Play menu

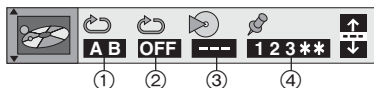

①	<b>A-B repeat</b> (⇒ page 17) <b>RAM DVD-A DVD-V VCD CD WMA MP3</b>	[ENTER]
②	<b>Repeat mode</b> (⇒ page 17) <b>RAM DVD-A DVD-V JPEG</b>	
③	<b>Play mode</b> (⇒ page 19) ---: Normal play PGM: Program play RND: Random play ALL: All group play ( <b>DVD-A</b> )	Display only
④	<b>Marker</b> <b>RAM DVD-A DVD-V VCD CD WMA MP3</b> <b>JPEG</b>	⇒ Page 20

### Audio menu

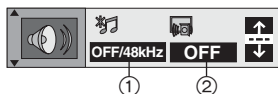

①	<b>Double re-master</b> (⇒ page 31) <b>RAM DVD-A DVD-V CD WMA MP3</b>
②	<b>Dialogue Enhancer on/off DVD-V</b> (Discs where the dialogue is recorded in the center channel) This makes the dialogue in movies easier to hear.

**Display menu**

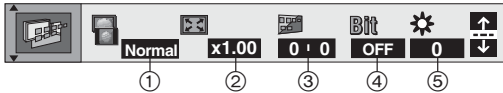

①	<p><b>4:3 Aspect</b>  <b>RAM DVD-A DVD-V VCD JPEG</b>                  Select how to show images made for 4:3 aspect screens on a 16:9 aspect television.</p> <ul style="list-style-type: none"> <li>● <b>Normal:</b> laterally stretches images made for a 4:3 screen.</li> <li>● <b>Auto:</b> expands suitable 4:3 letterbox images to fill more of the screen. Other images appear in full in the center of the screen.</li> <li>● <b>Shrink:</b> images appear in the center of the screen.</li> <li>● <b>Zoom:</b> expands all images to fill the screen. If your television has a similar feature, use it instead for a better effect.</li> </ul>
②	<p><b>Zoom</b> (→ page 20)  <b>RAM DVD-A DVD-V VCD</b></p> <div style="text-align: center;"> <p>[ENTER]</p> <p>↓</p> <p>[◀▶]</p> <p>↓</p> <p>[ENTER]</p> </div> <p>-----  <b>Making fine adjustments to the zoom ratio</b></p>
③	<p><b>Subtitle position/Subtitle brightness</b> <b>DVD-A DVD-V</b></p> <ul style="list-style-type: none"> <li>● Position (0 to -60): in 2 unit steps</li> <li>● Brightness (Auto*/0 to -9)</li> </ul> <p>*The brightness adjusts automatically against the background.</p>
④	<p><b>Bitrate display on/off</b> <b>RAM DVD-A DVD-V VCD</b>                  During play: shows the bitrate (approximate values) of the video being played                  While paused: shows the data volume of the frame and type of picture (→ page 37, Glossary—I/P/B)</p> <div style="border: 1px solid black; padding: 5px; margin: 10px 0;"> <p>9.438 Mbps ▶</p> <p style="text-align: center;">↑ [◀▶]</p> </div> <div style="border: 1px solid black; padding: 5px; margin: 10px 0;"> <p>• Bitrate</p> <p>Cur. 7.507 Mbps      5.0 Mbps</p> <p>Ave. 6.730 Mbps</p> </div> <p>Current bitrate      A record of bitrates for a sampling period.</p> <p style="text-align: center;">Average bitrate</p>
⑤	<p><b>OSD brightness</b> (-3 to +3)                  Adjust the brightness of the on-screen displays.</p>

**Picture menu**

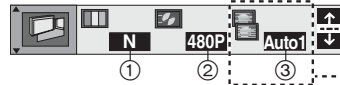

----- Only when "PROG." is on

①	<p><b>Picture mode</b> <b>RAM DVD-A DVD-V VCD JPEG</b></p> <ul style="list-style-type: none"> <li>● <b>N:</b> Normal mode</li> <li>● <b>S:</b> Soft mode (Soft picture with fewer video artifacts)</li> <li>● <b>F:</b> Fine mode (Details are sharper)</li> <li>● <b>C1:</b> Mellows images and enhances detail in dark scenes</li> <li>● <b>C2:</b> Sharpens images and enhances detail in dark scenes</li> <li>● <b>U1/U2:</b> User mode (→ below)</li> </ul>
②	<p><b>Video output mode</b> <b>RAM DVD-A DVD-V VCD JPEG</b></p> <ul style="list-style-type: none"> <li>● <b>480i:</b> Interlace video</li> <li>● <b>480P:</b> Progressive video ("PROG." is on)</li> </ul>
③	<p><b>Transfer mode</b> <b>RAM DVD-A DVD-V VCD</b>                  Select the method of conversion for progressive output to suit the type of material being played.</p> <ul style="list-style-type: none"> <li>● <b>Auto 1 (normal):</b> for viewing film material</li> <li>● <b>Auto 2:</b> for viewing film material (the same as Auto 1, but able to convert 30-frame-per-second progressive video)</li> <li>● <b>Video:</b> for video material</li> </ul>

**To change the user mode**

- 1 Select User mode and press [▶] to highlight the number.
- 2 Press [▲, ▼] to select "1" or "2".



**U1**

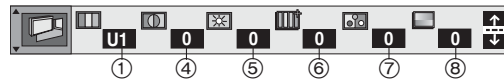

④	<p><b>Contrast</b> (-7 to +7)                  Increases the contrast between light and dark parts of the picture.</p>
⑤	<p><b>Brightness</b> (0 to +15)                  Brightens the picture.</p>
⑥	<p><b>Sharpness</b> (-7 to +7)                  Adjusts the sharpness of the edges of the horizontal lines.</p>
⑦	<p><b>Color</b> (-7 to +7)                  Adjust the shade of the picture's color.</p>
⑧	<p><b>Gamma</b> (0 to +5)                  Emphasis of outlines.</p>

**U2**

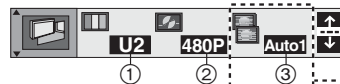

----- Only when "PROG." is on  
 ①-③ (→ above)

# The radio

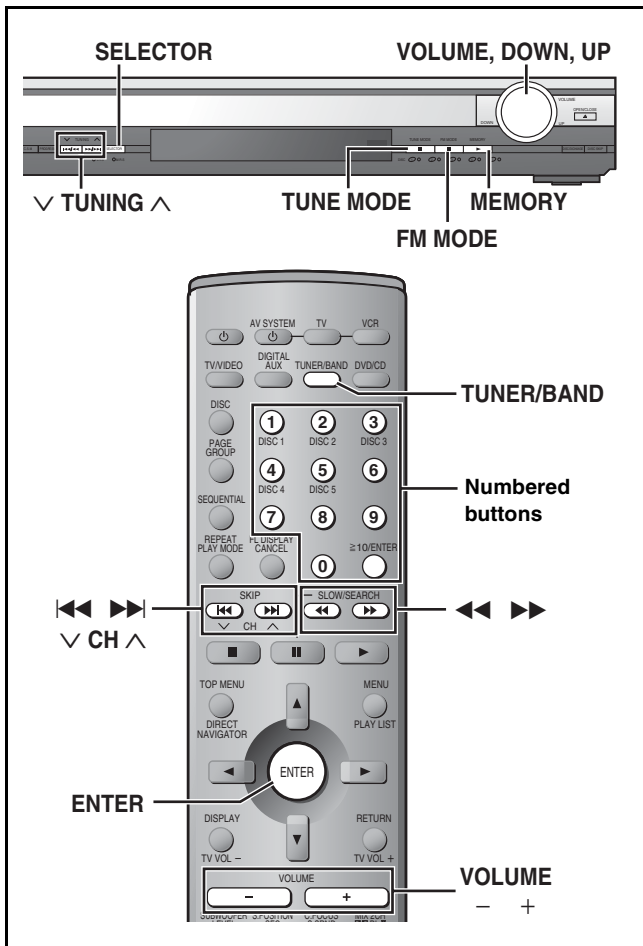

## Manual tuning

- 1 Press [SELECTOR] to select “FM” or “AM”.**

Each time you press the button:  
DVD/CD → FM → AM → TV → VCR → AUX → DIGITAL IN (HT900)

  - Remote control: Press [TUNER/BAND].
- 2 Press [TUNE MODE] to select “MANUAL”.**

Each time you press the button: MANUAL ↔ PRESET
- 3 Press [∇ TUNING] or [TUNING ▲] to select the frequency of the required station.**

  - Remote control: Press [◀◀] or [▶▶].

TUNED: Displayed when a radio station is tuned.

ST: Displayed when a stereo FM broadcast is being received.

Press and hold [∇ TUNING] or [TUNING ▲] until the frequency starts scrolling to start automatic tuning. Tuning stops when a station is found.
- 4 Adjust the volume.**

■ **If noise is excessive in FM**  
Press [FM MODE] to display “MONO”.

Press [FM MODE] again to cancel the mode. The mode is also canceled when you changed the frequency.

### ■ Allocation settings

Each country allocates broadcast bands according to their particular system.

**For U.S.A., Canada, and units with PX printed on the outer packaging**

You can change the FM step. The step is factory-set to 0.2 MHz, but you can change it to receive broadcasts allocated 0.1-MHz steps.

### For Latin America

You can change the AM step. The step is factory-set to 9 kHz, but you can change it to receive broadcasts allocated 10-kHz steps.

- 1 Press [TUNER/BAND] to select “FM” (for either band).
- 2 Press and hold [SELECTOR] on the main unit.

After a few seconds the display changes to show the current minimum frequency. Continue to hold the button down. The minimum frequency changes and the step is changed.

To return to the original step, repeat the above steps.

### Note

Any FM/AM frequencies preset in channels will be changed by this procedure. Preset them again.

## Preset tuning

Preset channels to make selection simple.

Up to 15 stations can each be set in the FM and AM bands.

### Automatic presetting

- 1 Tune to “FM 87.9 MHz” or “FM 87.5 MHz” (⇒ left).**

### For Latin America

Tune to “FM 87.50 MHz” (⇒ left).

- 2 Press and hold [ENTER].**

- Main unit: Press and hold [MEMORY]. Release the button when “FM AUTO” is displayed.

The tuner presets all the stations it can receive into the channels in ascending order. “SET OK” is displayed when the stations are set. The last station to be set is then played.

- 3 Tune to “AM 520 kHz”.**

### For Latin America

Tune to “AM 522 kHz” or “AM 520 kHz”.

- 4 Press and hold [ENTER].**

- Main unit: Press and hold [MEMORY].

### ■ “ERROR” is displayed

Presetting was unsuccessful. Preset manually.

### Manual presetting

- 1 Tune to the station (⇒ left).**
- 2 Press [ENTER].**
- 3 While “PGM” is flashing Press the numbered buttons to select a channel.**

Alternatively, press [◀◀, ∇ CH] or [▶▶, CH ▲] then press [ENTER].

CH 1

The station occupying a channel is erased if another station is preset in that channel.

### Selecting channels

- 1 Press [TUNER/BAND] to select “FM” or “AM”.**
- 2 Press the numbered buttons or [◀◀, ∇ CH] or [▶▶, CH ▲] to select the channel.**

CH 2

To select a 2-digit number

Example: To select channel 12, press [≥10] ⇒ [1] ⇒ [2]

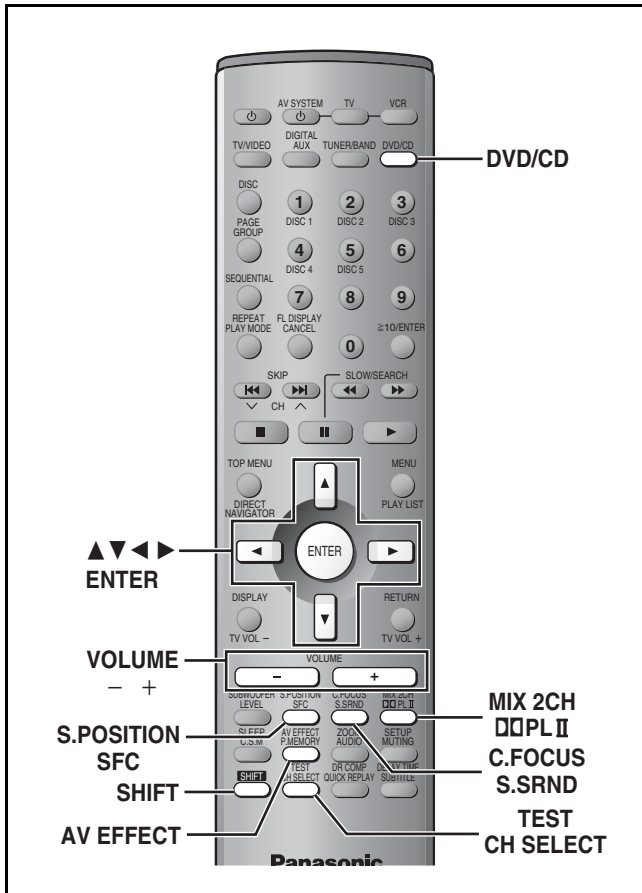

- Dolby Pro Logic, Dolby Pro Logic II, Super Surround, Center Focus, Multi Rear Surround, Virtual Rear Surround, Seat Position, Dynamic range compression and Subwoofer Level adjusting (➡ page 31) cannot be used if headphones are connected ("ERROR" appears on the display, excluding Seat Position).
- You may experience a reduction in sound quality when these sound field systems are used with some sources. If this occurs, turn the sound field system off.

## Dolby Digital and DTS

- Dolby Digital and DTS are digital encoding systems used on DVD to carry surround sound. Both were originally developed for use in cinemas.
- This unit automatically recognizes and decodes these systems.

Software encoded with Dolby Digital can be identified with this mark.



Software encoded with DTS can be identified with this mark.



## Play a Dolby Digital or DTS source.

The Dolby Digital or DTS indicator lights.



## ■ To down-mix Dolby Digital or DTS (multiple-channel) signals to 2 channels

Press [SHIFT]+[MIX 2CH].



To cancel, press [SHIFT]+[MIX 2CH] again.

**When "D.MIX" flashes on the display DVD-A**

The DVD-Audio contains multiple-channel signals that cannot be down-mixed.

## Dolby Pro Logic or Dolby Pro Logic II

**HT900**

The Dolby Pro Logic II processor works not only on sources recorded with Dolby Surround, but also on any stereo source. There is a difference in sound quality between Dolby Pro Logic and Dolby Pro Logic II.

### 1 Press [DOLBY II].

Each time you press the button:  
MUSIC → MOVIE → PANORAMA → (off)



**MUSIC:** Adds surround effects to stereo sources.

**MOVIE:** Use this mode when playing movie software, especially videotapes, recorded in Dolby Surround.

**PANORAMA:** Sound is spread out more so you feel like you are surrounded by music.

### 2 Play a Dolby Surround or stereo source.

**HT700 HT690**

Dolby Pro Logic is a decoding system that was developed to get a better sense of presence from sources encoded with Dolby Surround. The feeling of position has been improved by the addition of a separate center speaker channel.

Software encoded with Dolby Surround can be identified with this mark (DVD, CD, Video CD, Laser Disc, Video tape).



### 1 Press [DOLBY].

### 2 Play a Dolby Surround source.



**To cancel**

Press [DOLBY] or [DOLBY II] again.

**Note**

This does not work when playing multi-channel Dolby Digital.

## Speaker level adjustments

Adjust the level of the speakers so they are the same apparent level as the front speakers where you would normally be sitting and listening. (L, R ➡ page 29, "Balance")

**Preparation**

Press [DVD/CD].

### 1 Press [SHIFT]+[TEST] to output a test signal.

- Lch: Front left
- Cch: Center
- Rch: Front right
- RSch: Right surround
- LSch: Left surround

### 2 Press [VOLUME, +] or [-] to set the volume level normally used for listening.

### 3 Press [▲] (to increase) or [▼] (to decrease).

- C, RS, LS: -6 dB to +6 dB

To stop the test signal, press [SHIFT]+[TEST] again.

## ■ To adjust speaker level during play

### 1 Press [CH SELECT] to select the speaker.

Lch→Cch→Rch→RSch→LSch→SWch

SWch: Subwoofer

- You can only adjust SWch if the disc includes a subwoofer channel.
- SWch does not appear on the display and is not adjustable when Dolby Pro Logic or Dolby Pro Logic II is turned on.

### 2 Press [▲] (to increase) or [▼] (to decrease).

L, R: (⇒ below)

C, RS, LS: -6 dB to +6 dB

SW: -6 dB to +6 dB

## Balance

You can adjust the balance of the front speakers.

### 1 Press [CH SELECT] to select "L" or "R".

### 2 Press [◀, ▶].

- When testing signal, you can also adjust the "L" or "R" balance of the front right and left speakers by pressing [◀, ▶].

## Super Surround

Add surround effects to stereo sound.

### Press [S.SRND].

Each time you press the button:

MUSIC→MOVIE→PARTY→(off)

S.SRND

**MUSIC:** Adds surround effects to stereo sources.

**MOVIE:** Use this mode when playing movie software.

**PARTY:** Sound is in stereo regardless of the direction you are facing.

- You can adjust the volume of the surround speakers to get the best surround effect (⇒ page 28, Speaker level adjustments).

### Note

- Turn Super Surround off when playing a DVD recorded with Dolby Digital or DTS. The surround effects will not be reproduced correctly if this is left on.
- Dolby Pro Logic or Dolby Pro Logic II (⇒ page 28) switches off.

## Sound Field Control

### Press [SFC] to select a setting.

Each time you press the button:

**HEAVY:** Adds punch to rock.

**CLEAR:** Clarifies higher sounds.

**SOFT:** For background music.

**DISCO:** Reverberates sound to make you feel like you were in a disco.

**LIVE:** Makes vocals more alive.

**HALL:** Expands sound to make you feel like you were in a hall.

**FLAT:** Canceled (no effect is added) (factory preset).

### To check the current setting

Press [SFC].

## Center Focus

You can make the sound of the center speaker seem like it is coming from within the television.

### Press [SHIFT]+[C. FOCUS].

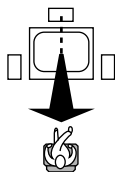

C.F

Each time you press the button:

CENTER FOCUS ON ↔ CENTER FOCUS OFF

- This does not work when Super Surround is turned on.
- This will have less effect when Dolby Pro Logic or Dolby Pro Logic II is turned on.

## Multi Rear Surround (M.R.S)/ Virtual Rear Surround (V.R.S)

### HT900

### ■ Multi Rear Surround (M.R.S)

This mode makes it seem like sound is coming from multiple rear surround speakers virtually when connected with surround speakers.

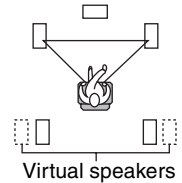

### ■ Virtual Rear Surround (V.R.S)

This mode is useful if you have to place your surround speakers near the front speakers due to the layout of your room.

This mode makes it seem like the sound from the surround speakers is coming from behind you.

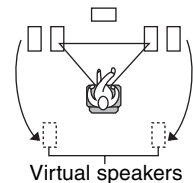

## 1 Press and hold [SHIFT]+[AV EFFECT] to select M.R.S mode or V.R.S mode.

Each time you press and hold the button:

M.R.S mode ↔ V.R.S mode

- "M.R.S" indicator lights when M.R.S mode turns on.
- "V.R.S" indicator lights when V.R.S mode turns on.

## 2 Press [SHIFT]+[AV EFFECT].

Each time you press the button:

### M.R.S mode

M.R.S 1 (Normal) → M.R.S 2 (Enhanced) → M.R.S OFF

### V.R.S mode

V.R.S 1 (Normal) → V.R.S 2 (Enhanced) → V.R.S OFF

## Seat Position

Using this function makes you feel like you are sitting in the ideal seating position (in the center of the circle formed by the speakers), even if you cannot due to the layout of your room.

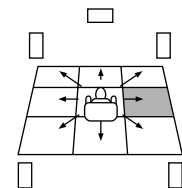

## 1 Press [SHIFT]+[S.POSITION].

S.POS

## 2 While "S.POS" is flashing

### Press [▲, ▼, ◀, ▶] to select a position.

S.POS

### To cancel

Press [SHIFT]+[S.POSITION] to clear "S.POS".

### Note

While virtual rear surround is on, the seat position is changed in three horizontal steps.

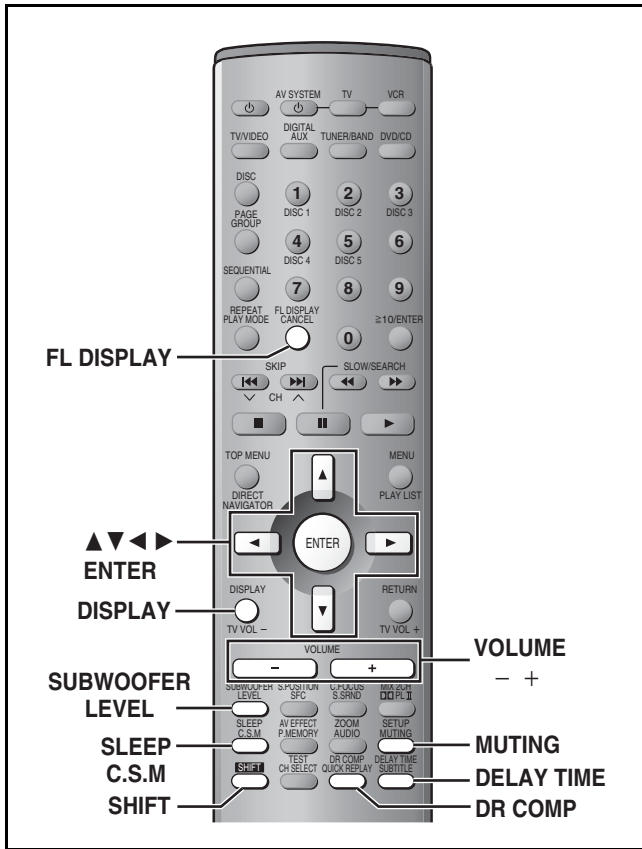

## Custom Sound Memory—Store the sound settings

DVD-A DVD-V VCD CD

Store the sound settings for a disc so the unit recalls them the next time you play it.

- Number of discs: 30
- Settings: Dolby Pro Logic, Dolby Pro Logic II, Subwoofer level, Center Focus, Sound Field Control, Super Surround

### Store the settings

- 1 Make the settings.
- 2 Press and hold [C.S.M.].



### Recall the settings

The unit recalls the settings when you play the disc again.

- The settings are replaced if you change them.
- When you store settings for a 31st disc, the earliest settings disappear.
- Press [C.S.M.] while "CSM" is lit and the settings return to those that were on before the settings are recalled.
- Press [C.S.M.] while "CSM" is out and you are playing a disc for which you stored settings and those settings are recalled.

## Changing the delay time

HT900

Enhance sound perception using this feature. Adjust the delay time for Dolby Digital when "DIGITAL IN" is selected as the source when connected with a satellite receiver or for Dolby Pro Logic II when Dolby Pro Logic II is turned on.

Adjust the Dolby Digital delay time settings from the SETUP menu when not using a "DIGITAL IN" source (→ page 35).

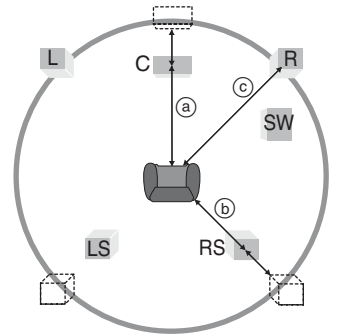

### 1 Press [SHIFT]+[DELAY TIME].

Each time you press the button:

Sch ↔ Cch

"Cch" appears only when Dolby Pro Logic II is turned off.

### 2 Press [▲, ▼] to adjust.

#### Values

If distance (a) or (b) is greater than or equal to distance (c), set to "0".

If distance (a) or (b) is less than distance (c), set as follows.

#### When Dolby Digital is being received

##### (a) Center speaker

Difference	Setting
15–45 cm (5 <sup>15</sup> / <sub>16</sub> "–17 <sup>3</sup> / <sub>4</sub> "	1 ms
46–75 cm (18 <sup>1</sup> / <sub>8</sub> "–29 <sup>3</sup> / <sub>16</sub> "	2 ms
76–105 cm (29 <sup>15</sup> / <sub>16</sub> "–41 <sup>3</sup> / <sub>8</sub> "	3 ms
106–135 cm (41 <sup>3</sup> / <sub>4</sub> "–53 <sup>3</sup> / <sub>16</sub> "	4 ms
136–165 cm (53 <sup>9</sup> / <sub>16</sub> "–65"	5 ms

##### (b) Surround speakers

Difference	Setting
75–225 cm (29 <sup>9</sup> / <sub>16</sub> "–88 <sup>5</sup> / <sub>8</sub> "	5 ms
226–375 cm (89"–147 <sup>11</sup> / <sub>16</sub> "	10 ms
376–525 cm (148 <sup>1</sup> / <sub>16</sub> "–206 <sup>3</sup> / <sub>4</sub> "	15 ms

When you change the surround speaker setting for Dolby Digital, the setting also changes for Dolby Pro Logic II.

E.g., the setting for MUSIC and PANORAMA are the same as that for Dolby Digital.

Dolby Digital	Dolby Pro Logic II		
	MUSIC	MOVIE	PANORAMA
0 ms	0 ms	10 ms	0 ms
5 ms	5 ms	15 ms	5 ms
10 ms	10 ms	20 ms	10 ms
15 ms	15 ms	25 ms	15 ms

## Sound quality

### Adjusting the bass

Press [SUBWOOFER LEVEL].

SUB W 2

Each time you press the button:  
SUB W 1 → SUB W 2 → SUB W 3 → SUB W 4 (factory preset)

### Double re-master—Enjoying more natural sound

RAM DVD-A DVD-V CD

Discs recorded with 2-channel LPCM at 44.1 kHz or 48 kHz

This feature gives you a more natural sound by adding the higher frequency signals not recorded on the disc.

WMA MP3

Discs recorded at 44.1 kHz or 48 kHz

This feature reproduces the frequencies lost during recording to give you a sound closer to the original.

**1** During play

Press [DISPLAY] until the unit information screen is displayed (→ page 25).

**2** Press [▲, ▼] to select the audio menu.



Double Re-master

**3** Press [◀, ▶] to select “Double Re-master”.

**4** Press [▲, ▼].

Each time you press the button:

Setting	RAM DVD-A DVD-V CD	WMA MP3
	Type of music	Effect level
1	High tempo (e.g., pops and rock)	Light
2	Various tempos (e.g., jazz)	Medium
3	Low tempo (e.g., classical)	Strong
OFF	Off	Off

#### Note

HT900 This doesn't work if input is “DIGITAL IN”.

### DR COMP—Dynamic range compression

#### HT900

Change this setting to listen to a source recorded with Dolby Digital when “DIGITAL IN” is selected as the source at low volume (such as late at night) and maintain audio clarity. This setting reduces the peak level in loud scenes without affecting the sound field.

Press [SHIFT]+[DR COMP].

Each time you press the button:

STANDARD → MAX → OFF

STANDARD: The level recommended by the producer of the source for household viewing.

MAX: The maximum allowable compression (recommended for night viewing).

OFF: Source is played with the original dynamic range (factory setting).

## Convenient functions

### Muting the volume

Press [MUTING].

MUTING

Volume is reduced to minimum.

#### To cancel

Press [MUTING] again or reduce the volume to minimum (— dB), then raise it to the required level.

Muting is also canceled when you switch the unit to standby.

### Dimming the display

Press [SHIFT]+[FL DISPLAY].

To return to the original brightness, press [SHIFT]+[FL DISPLAY] again.

The display also returns to the original brightness when you switch the unit to standby.

### The sleep timer

This timer turns the unit off after a set time.

Press [SHIFT]+[SLEEP] to select the time (minutes).

SLEEP 30

Each time you press the button:  
SLEEP 30 → SLEEP 60 → SLEEP 90 → SLEEP 120  
SLEEP OFF

#### To cancel the timer

Press [SHIFT]+[SLEEP] to select “SLEEP OFF”.

#### To check the SLEEP setting

Press [SHIFT]+[SLEEP] once.

• The time remaining appears.

#### To change the setting

Press [SHIFT]+[SLEEP] to display the remaining time, then press again to select the required time.

### Using headphones

**1** Reduce the volume and connect the headphones (not included).

Headphone plug type: 3.5 mm (1/8") stereo

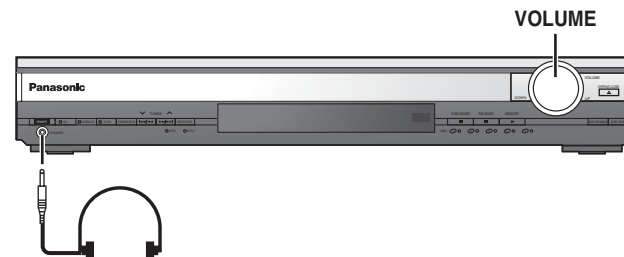

**2** Adjust headphone volume with [VOLUME].

Audio is automatically switched to stereo (2-channel).

#### Note

Avoid listening for prolonged periods of time to prevent hearing damage.

## Connection example

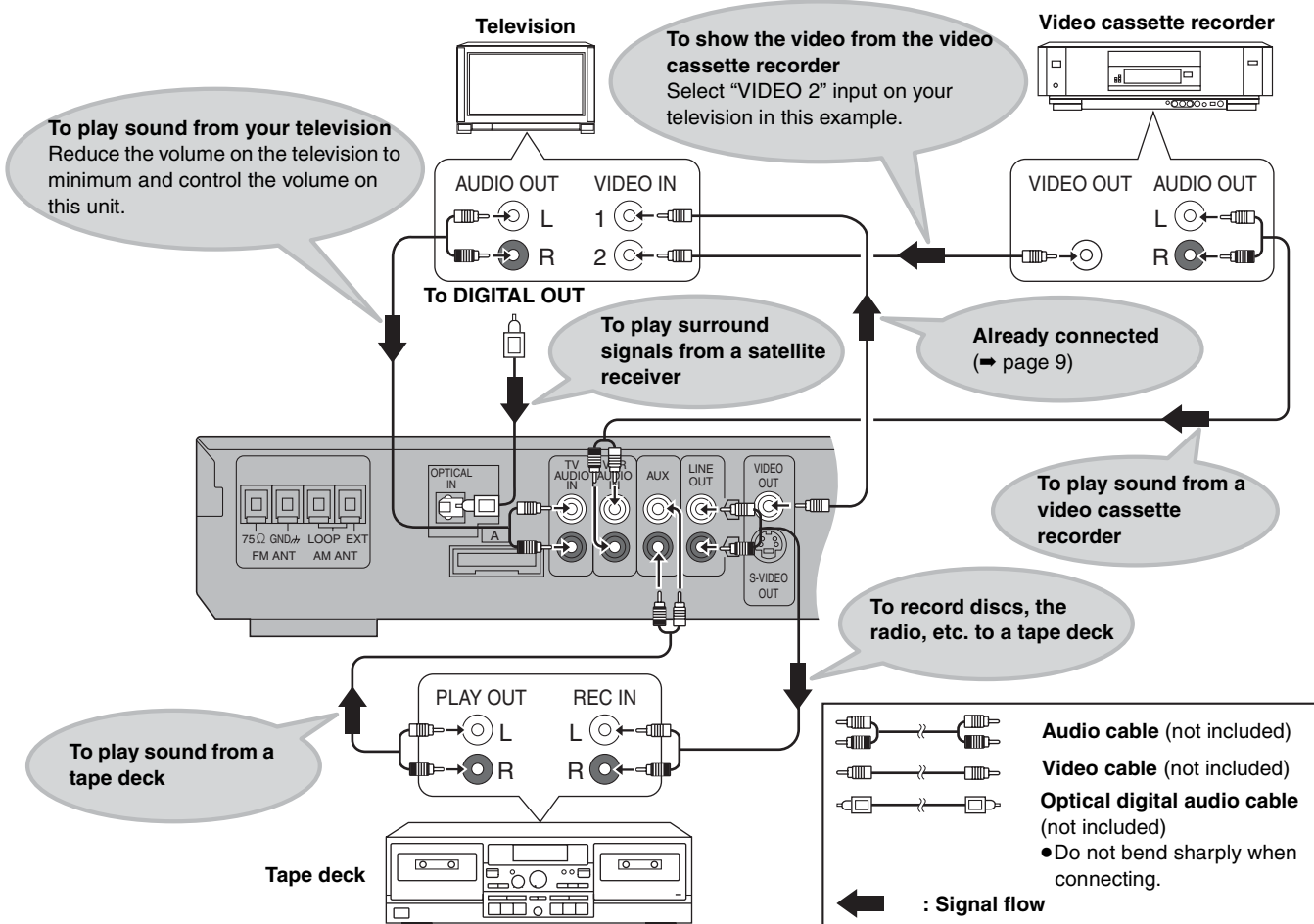

Other functions

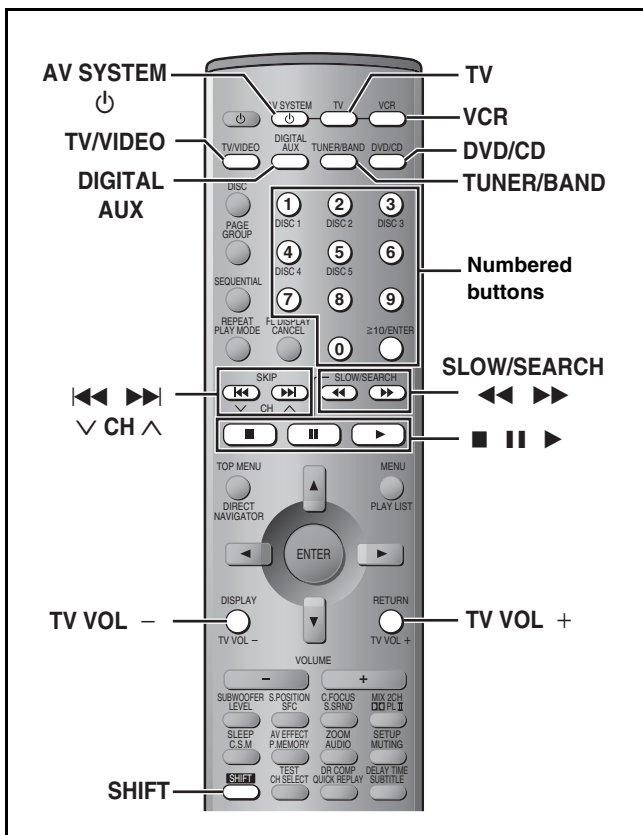

## Operating the television and the video cassette recorder

You can use the remote control to operate a Panasonic television or a video cassette recorder. (Some models cannot be operated by this remote control.)

### Television

#### Preparation

- Face the remote control at this unit and press [TV]. The button lights and "TV" appears on the unit's display. You can operate the television.
- Face the remote control at the television for the following operations.

#### Turning the television on/off

Press [AV SYSTEM].

#### Switching the television's video input mode

Press [TV/VIDEO].

#### Changing channels

Press [CH v], [CH ^] or [SKIP].

- [≥10/ENTER] is used to confirm channel selection on some televisions manufactured by other companies.

#### Adjusting the volume

Press [TV VOL+] or [TV VOL-].



## Video cassette recorder

### Preparation

- Face the remote control at this unit and press [VCR]. The button lights and "VCR" appears on the unit's display. You can operate the video cassette recorder.
- Change the video input mode on the television ("VIDEO 2" in the example).
- Face the remote control at the video cassette recorder for the following operations.

### Turning the video cassette recorder on/off

Press [⏻ AV SYSTEM].

### Play, pause and stop

Press [▶], [⏸] or [■].

### Fast forward and rewind

Press [◀◀] or [▶▶].

## You can connect a laser disc or record player instead of a video cassette recorder.

Connect as shown on page 32 and select "VCR" as the source.

### When connecting a record player

We recommend using a record player with a built-in phono equalizer. If your player doesn't have a built-in equalizer, connect it first to a separate equalizer and then connect that to this unit.

## Changing the remote control code

This remote control can also operate some other brands of televisions and video cassette recorders. Change the code to operate such equipment and some Panasonic products.

While aiming the remote control at the equipment,

Press and hold [TV] or [VCR],

Press a numbered button to enter the first digit,

Press a numbered button to enter the second digit.

The remote control outputs the on/off signal.

If the code is correct, the equipment turns on or off.

If it doesn't, try entering another code.

- Note that this remote control cannot operate some equipment and that it may not be able to perform some operations.
- Reenter the codes after you change the batteries.

## Television code list

Panasonic:	01, 02, 26	Philco:	06, 07
Sony:	04	Philips:	06
Fisher:	14	Pioneer:	02, 10, 19
G-E:	02, 03, 07, 09	Quasar:	02
Gold Star:	07, 15	RCA:	03, 07, 09, 13, 23, 24, 25
Hitachi:	05, 07	Sanyo:	14
JVC:	12	Sharp:	08, 21
LXI:	03, 06, 07, 10, 14, 15	Sylvania:	06, 07, 15
Magnavox:	06, 07, 11, 15, 22	Symphonic:	17
Mitsubishi:	07, 15, 16, 21	Toshiba:	10, 21
NEC:	07, 15	Zenith:	18, 20

## Video cassette recorder code list

Panasonic:	01, 02, 09, 33	NEC:	19, 25, 31, 38
Sony:	05, 06, 07, 35, 36, 37	Philco:	02, 09, 12, 30
Fisher:	13, 14, 15, 18, 34	Philips:	02, 09, 12
Funai:	08, 30	Pioneer:	09
G-E:	02, 03, 11	Quasar:	01, 02, 09, 33
Gold Star:	27	RCA:	02, 03, 04, 09, 10, 11, 12, 23, 24, 26
Hitachi:	09, 10, 11	Sanyo:	14, 18, 34
JVC:	19, 25, 31, 38, 39, 40	Sharp:	16, 17
LXI:	10, 13, 14, 15, 18, 27, 30	Shintom:	32
Magnavox:	02, 09, 12	Sylvania:	02, 09, 12, 30
Mitsubishi:	21, 22, 28, 29	Symphonic:	30
		Toshiba:	23, 24
		Zenith:	20

## Operating the tape deck or satellite receiver

### Listening to the tape deck

Press [AUX] to select "AUX" as the source.

### Recording to the tape deck

- 1 • **Disc**  
Press [DVD/CD] to select "DVD/CD".
- **The radio**  
Press [TUNER/BAND] to select "FM" or "AM".
- 2 Start recording and play.

### Listening to the surround signals from a satellite receiver

#### HT900

This unit can decode the surround signals received through satellite broadcasts. Refer to your satellite receiver's operating instructions for details.





Press [SHIFT]+[DIGITAL] to select "DIGITAL IN" as the source.

- Main unit: Press [DIGITAL IN].

# Changing settings

This chart shows the settings for this unit. Change the settings to suit your preferences and to suit the unit to the environment in which it is being used. These settings are retained in memory until they are changed, even if the unit is turned off. See page 35 for details on menu operation.

• Underlined items are the factory preset.

Menus	Items	Options
<b>Disc</b> 	<b>Audio</b> Choose the preferred audio language.	<u>English</u> French    Spanish    Original    Other **** Original:        The original language of each disc will be selected. Other ****:    Input a code number with the numbered buttons (⇒ page 36).
	<b>Subtitle</b> Choose the preferred subtitle language.	<u>Automatic</u> English    French    Spanish    Other **** Automatic:    If the language selected for "Audio" is not available, subtitles of that language will automatically appear if available on that disc.
	<b>Menus</b> Choose the preferred language for disc menus.	<u>English</u> French    Spanish    Other ****
	<b>Ratings</b> (⇒ page 35) Set a ratings level to limit DVD-Video play. • The password screen is shown if you choose levels 0 to 7 or if you choose "Ratings" when levels 0 to 7 have been selected. • Select "Level 0" to prevent play of discs that do not have ratings levels recorded on them.	<b>Setting ratings (When level 8 is selected)</b> <b>8 No Limit:</b> All DVD-Video can be played. 1 to 7:        Prohibits play of DVD-Video with corresponding ratings recorded on them. 0 Lock All:    Prohibits play of all DVD-Video. <hr style="border-top: 1px dashed black;"/> <b>Changing ratings (When level 0–7 is selected)</b> Unlock Player        Change Level Change Password    Temporary Unlock
<b>Video</b> 	<b>TV Aspect</b> (⇒ page 12) Choose the setting to suit your television and preference.	<u>4:3 Pan&amp;Scan</u> 4:3 Letterbox        16:9
	<b>TV Type</b> (⇒ page 12) Select to suit the type of television.	<u>Standard (Direct View TV)</u> CRT Projector        LCD TV/Projector Projection TV        Plasma TV
	<b>Still Mode</b> Specify the type of picture shown when paused.	<u>Automatic</u> Field        Frame
	<b>Black Level Control</b> Change the black level of the picture if you connected a television through the COMPONENT VIDEO OUT terminals.	<u>Lighter:</u> when connected to a TV through the VIDEO OUT or S-VIDEO OUT terminal. <u>Darker:</u> when connected to a TV through the COMPONENT VIDEO OUT (Y/P <sub>B</sub> /P <sub>R</sub> ) terminals.
<b>Audio</b> 	<b>Speaker Setting</b> (⇒ page 35) Set the delay time for your center and surround speakers.	Multi-channel Center:                0/1.3/2.6/3.9/5.3 ms Surround (L/R):    0/5.3/10.6/15.9 ms
	<b>Dynamic Range Compression</b> (Dolby Digital only) Change the dynamic range for late night viewing.	<u>Off</u> On: For clear dialog when listening at low volume.
	<b>Audio during Search</b> Choose whether to have sound during search.	<u>On</u> Off • This feature doesn't work for some discs.
<b>Display</b> 	<b>Menu Language</b> Choose the preferred language for these menus and the on-screen messages.	<u>English</u> Français                Español
	<b>On-Screen Messages</b> Choose whether to show on-screen messages or not.	<u>On</u> Off
<b>Others</b> 	<b>HighMAT</b> Play HighMAT discs as HighMAT discs, or as regular WMA/MP3/JPEG discs.	<u>Enable:</u> Play HighMAT discs as HighMAT discs. Disable:    Play HighMAT discs as regular WMA/MP3/JPEG discs.
	<b>Mixed Disc—Audio &amp; Stills</b> Select the type of file played on discs containing both JPEG and WMA/MP3.	<u>Audio (MP3/WMA)</u> Stills (JPEG)
	<b>DVD-Video Mode</b> Select how to play pictures contained on some DVD-Audio. The setting returns to "Off" when you remove the disc, turn the unit off or change the source.	<u>Off:</u> DVD-Audio are played as DVD-Audio. On:        DVD-Video contents found on DVD-Audio can be played.
	<b>QUICK SETUP</b> (⇒ page 12) Answer questions to make basic settings.	Yes (Menu language, Audio language, Subtitle language, TV type, TV aspect) <u>No</u>



Language code list

Abkhazian: 6566	Chinese: 9072	Hausa: 7265	Lithuanian: 7684	Romanian: 8279	Telugu: 8469
Afar: 6565	Corsican: 6779	Hebrew: 7387	Macedonian: 7775	Russian: 8285	Thai: 8472
Afrikaans: 6570	Croatian: 7282	Hindi: 7273	Malagasy: 7771	Samoan: 8377	Tibetan: 6679
Albanian: 8381	Czech: 6783	Hungarian: 7285	Malay: 7783	Sanskrit: 8365	Tigrinya: 8473
Ameharic: 6577	Danish: 6865	Icelandic: 7383	Malayalam: 7776	Scots Gaelic: 7168	Tonga: 8479
Arabic: 6582	Dutch: 7876	Indonesian: 7378	Maltese: 7784	Serbian: 8382	Turkish: 8482
Armenian: 7289	English: 6978	Interlingua: 7365	Maori: 7773	Serbo-Croatian: 8372	Turkmen: 8475
Assamese: 6583	Esperanto: 6979	Irish: 7165	Marathi: 7782	Shona: 8378	Twi: 8487
Aymara: 6588	Estonian: 6984	Italian: 7384	Moldavian: 7779	Sindhi: 8368	Ukrainian: 8575
Azerbaijani: 6590	Faroese: 7079	Japanese: 7465	Mongolian: 7778	Singhalese: 8373	Urdu: 8582
Bashkir: 6665	Fiji: 7074	Javanese: 7487	Nauru: 7865	Slovak: 8375	Uzbek: 8590
Basque: 6985	Finnish: 7073	Kannada: 7578	Nepali: 7869	Slovenian: 8376	Vietnamese: 8673
Bengali; Bangla: 6678	French: 7082	Kashmiri: 7583	Norwegian: 7879	Somali: 8379	Volapük: 8679
Bhutani: 6890	Frisian: 7089	Kazakh: 7575	Oriya: 7982	Spanish: 6983	Welsh: 6789
Bihari: 6672	Galician: 7176	Kirghiz: 7589	Pashto, Pushto: 8083	Sundanese: 8385	Wolof: 8779
Breton: 6682	Georgian: 7565	Korean: 7579	Persian: 7065	Swahili: 8387	Xhosa: 8872
Bulgarian: 6671	German: 6869	Kurdish: 7585	Polish: 8076	Swedish: 8386	Yiddish: 7473
Burmese: 7789	Greek: 6976	Laotian: 7679	Portuguese: 8084	Tagalog: 8476	Yoruba: 8979
Byelorussian: 6669	Greenlandic: 7576	Latin: 7665	Punjabi: 8065	Tajik: 8471	Zulu: 9085
Cambodian: 7577	Guarani: 7178	Latvian, Lettish: 7686	Quechua: 8185	Tamil: 8465	
Catalan: 6765	Gujarati: 7185	Lingala: 7678	Rhaeto-Romance: 8277	Tatar: 8484	

Optional antenna connections

Use outdoor antennas if radio reception is poor.

Note

Disconnect the antenna when the unit is not in use.  
Do not use the outdoor antenna during an electrical storm.

Other functions

Leave the loop antenna connected.

AM outdoor antenna (Using a vinyl wire)

Run a piece of vinyl wire horizontally across a window or other convenient location.

5–12 m  
(16–39 feet)

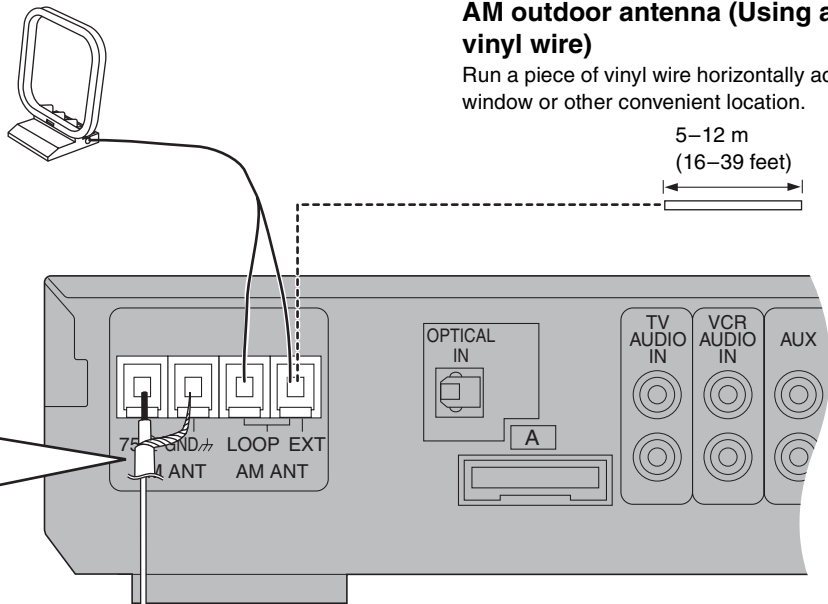

- 1 Remove a piece of the outer vinyl insulator.



- 2 Twist the shield braid.

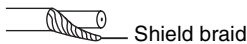

- 3 Expose the core wire.

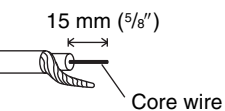

FM outdoor antenna (Using a television antenna)

- Disconnect the FM indoor antenna.
- The antenna should be installed by a competent technician.

75 Ω coaxial cable  
(not included)

## Decoder

A decoder restores the coded audio signals on DVDs to normal. This is called decoding.

## Dolby Digital

This is a method of coding digital signals developed by Dolby Laboratories. Apart from stereo (2-channel) audio, these signals can also be multi-channel audio. A large amount of audio information can be recorded on one disc using this method.

## DTS (Digital Theater Systems)

This surround system is used in many movie theaters around the world. There is good separation between the channels, so realistic sound effects are possible.

## Dynamic range

Dynamic range is the difference between the lowest level of sound that can be heard above the noise of the equipment and the highest level of sound before distortion occurs.

## Film and video

DVD-Videos are recorded using either film or video. Usually, film is recorded at 24 frames per second, the rate movies are filmed at, while video is recorded at 30 frames per second.

## Frame still and field still

Frames are the still pictures that go together to make a moving picture. There are about 30 frames shown each second. One frame is made up of two fields. A regular television shows these fields one after the other to create frames.

A still is shown when you pause a moving picture. A frame still is made up of two alternating fields, so the picture may appear blurred, but overall quality is high.

A field still is not blurred, but it has only half the information of a frame still so picture quality is lower.

## Interlace and progressive output

NTSC, the video signal standard, has 480 interlaced (I) scan lines, whereas progressive scanning uses twice the number of scan lines. This is called 480P. The video signals output from this unit's COMPONENT VIDEO OUT terminals (Y, P<sub>B</sub>, P<sub>R</sub>) allow you to enjoy higher quality pictures than if the signals were output from the VIDEO OUT terminal or S-VIDEO OUT terminal.

## I/P/B

MPEG 2, the video compression standard adopted for use with DVD-Video, codes frames using these 3 picture types.

### I: Intra coded picture

This picture has the best quality and is the best to use when adjusting the picture.

### P: Predictive coded picture

This picture is calculated based on past I or P-pictures.

### B: Bidirectionally-predictive coded picture

This picture is calculated by comparing past and future I and P-pictures so it has the lowest volume of information.

## Linear PCM (pulse code modulation)

These are uncompressed digital signals, similar to those found on CDs.

## Playback control (PBC)

If a Video CD has playback control, you can select scenes and information with menus.

## WMA, MP3, CD text and JPEG information

- Discs must conform to ISO9660 level 1 or 2 (except for extended formats).
- This unit is compatible with multi-session but if there are a lot of sessions it takes more time for play to start. Keep the number of sessions to a minimum to avoid this.
- The order tracks appear in the menus may differ to the order shown on your computer.

### WMA

- Noise may occur when playing WMA files.
- You cannot play WMA files that are copy protected.

### MP3

- This unit is not compatible with ID3 tags.
- If you play an MP3 track that includes still picture data, it will take some time before the music itself starts playing and the elapsed time will not be displayed during this time. Even after the track starts, the correct play time will not be displayed.

### JPEG

- To view JPEG files on this unit:
  - Take them on a digital camera that meets the DCF (Design rule for Camera File System) standard. Some digital cameras have functions that are not supported by the DCF standard like automatic picture rotation which may render a picture unviewable.
  - Do not alter the files in any way or save them under a different name.
- This unit cannot display moving pictures, Motion JPEG and other such formats, still pictures other than JPEG (i.e. TIFF) or play associated sound.

## Order of play

WMA MP3 JPEG

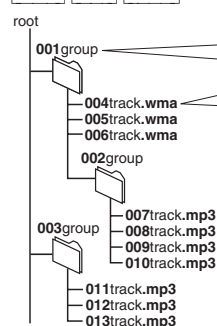

### Naming folders and files

Prefix folder and file names with 3-digit numbers in the order you want to play them.

Extension  
004track.wma (or .WMA)

The extension for MP3 is ".mp3" or ".MP3".

The extension for JPEG is ".JPG", ".jpg", ".JPEG" or ".jpeg".

### CD (CD text only)

#### When making your own CD text discs

The unit plays the tracks in the order you record them so you do not have to prefix the titles with numbers.

Windows Media, and the Windows logo are trademarks, or registered trademarks of Microsoft Corporation in the United States and/or other countries.



WMA is a compression format developed by Microsoft Corporation. It achieves the same sound quality as MP3 with a file size that is smaller than that of MP3.

MPEG Layer-3 audio decoding technology licensed from Fraunhofer IIS and Thomson multimedia.

## AMPLIFIER SECTION

### HT900

<b>RMS Output Power: Dolby Digital Mode, 10 % Total Harmonic</b>	
Distortion	
1 kHz Front CH	60 W per channel (6 Ω)
1 kHz Surround CH	60 W per channel (6 Ω)
1 kHz Center CH	220 W per channel (6 Ω)
100 Hz Subwoofer CH	240 W per channel (4 Ω)
<b>Total RMS Dolby Digital Mode Power</b>	700 W
<b>FTC Output Power: Dolby Digital Mode, 1 % Total Harmonic</b>	
Distortion	
120 Hz–20 kHz Front CH	35 W per channel (6 Ω)
120 Hz–20 kHz Surround CH	35 W per channel (6 Ω)
120 Hz–20 kHz Center CH	140 W per channel (6 Ω)
45 Hz–120 Hz Subwoofer CH	150 W per channel (4 Ω)
<b>Total FTC Dolby Digital Mode Power</b>	430 W
<b>Input sensitivity/Input impedance</b>	
AUX	250 mV, 15 kΩ

### HT700

<b>RMS Output Power: Dolby Digital Mode, 10 % Total Harmonic</b>	
Distortion	
1 kHz Front CH	55 W per channel (6 Ω)
1 kHz Surround CH	55 W per channel (6 Ω)
1 kHz Center CH	160 W per channel (6 Ω)
100 Hz Subwoofer CH	220 W per channel (4 Ω)
<b>Total RMS Dolby Digital Mode Power</b>	600 W
<b>FTC Output Power: Dolby Digital Mode, 1 % Total Harmonic</b>	
Distortion	
120 Hz–20 kHz Front CH	30 W per channel (6 Ω)
120 Hz–20 kHz Surround CH	30 W per channel (6 Ω)
120 Hz–20 kHz Center CH	110 W per channel (6 Ω)
45 Hz–120 Hz Subwoofer CH	140 W per channel (4 Ω)
<b>Total FTC Dolby Digital Mode Power</b>	370 W
<b>Input sensitivity/Input impedance</b>	
AUX	250 mV, 15 kΩ
<b>For Latin America only, PMPO Output Power</b>	5200 W

### HT690

<b>RMS Output Power: Dolby Digital Mode, 10 % Total Harmonic</b>	
Distortion	
1 kHz Front CH	50 W per channel (6 Ω)
1 kHz Surround CH	50 W per channel (6 Ω)
1 kHz Center CH	100 W per channel (6 Ω)
100 Hz Subwoofer CH	200 W per channel (4 Ω)
<b>Total RMS Dolby Digital Mode Power</b>	500 W
<b>FTC Output Power: Dolby Digital Mode, 1 % Total Harmonic</b>	
Distortion	
120 Hz–20 kHz Front CH	27 W per channel (6 Ω)
120 Hz–20 kHz Surround CH	27 W per channel (6 Ω)
120 Hz–20 kHz Center CH	62 W per channel (6 Ω)
45 Hz–120 Hz Subwoofer CH	130 W per channel (4 Ω)
<b>Total FTC Dolby Digital Mode Power</b>	300 W
<b>Input sensitivity/Input impedance</b>	
AUX	250 mV, 15 kΩ

## FM TUNER SECTION

### Frequency range

**For U.S.A., Canada, and units with PX printed on the outer packaging**

87.9–107.9 MHz (200-kHz step)
87.5–108.0 MHz (100-kHz step)

**For Latin America**

87.50–108.00 MHz (50-kHz step)
--------------------------------

<b>Sensitivity</b>	
S/N 26 dB	2.5 μV (IHF)
	2.2 μV
<b>Antenna terminals</b>	
	75 Ω (unbalanced)
<b>Preset station</b>	
	15

## AM TUNER SECTION

**For U.S.A., Canada, and units with PX printed on the outer packaging**

<b>Frequency range</b>	520–1710 kHz (10-kHz step)
<b>AM Sensitivity S/N 20 dB at 1000 kHz</b>	560 μV/m
<b>Preset station</b>	15

**For Latin America**

<b>Frequency range</b>	522–1629 kHz (9-kHz step)
	520–1630 kHz (10-kHz step)
<b>AM Sensitivity S/N 20 dB at 999 kHz</b>	560 μV/m
<b>Preset station</b>	15

## DISC SECTION

### Discs played [8 cm (3") or 12 cm (5")]

- (1) DVD-RAM (DVD-VR formatted disc)
- (2) DVD-Audio
- (3) DVD-Video
- (4) DVD-R (DVD-Video formatted disc)
- (5) CD-Audio (CD-DA)
- (6) Video CD
- (7) SVCD (Conforming to IEC62107)
- (8) CD-R/CD-RW (CD-DA, Video-CD formatted disc)
- (9) MP3/WMA
  - Maximum number of tracks and groups recognizable: 999 tracks and 99 groups
  - Compatible compression rate:
    - MP3: between 32 kbps and 320 kbps
    - WMA: between 48 kbps and 192 kbps
- (10) JPEG
  - Exif Ver 2.1 JPEG Baseline files
  - Maximum number of pictures and groups recognizable: 3000 pictures and 300 groups
  - Picture resolution: between 320×240 and 6144×4096 pixels (Sub sampling is 4:2:2 or 4:2:0)
- (11) HighMAT Level 2 (Audio and Image)

### Video

<b>Signal system</b>		NTSC
<b>Output level</b>	Composite video	1 Vp-p (75 Ω)
	S-video Y output level	1 Vp-p (75 Ω)
	C output level	0.286 Vp-p (75 Ω)
	Component video (Y: green, Pb: blue, Pr: red)	
	Y output level	1 Vp-p (75 Ω)
	Pb output level	0.7 Vp-p (75 Ω)
	Pr output level	0.7 Vp-p (75 Ω)

### Audio

<b>Sampling frequency</b>	
CD	44.1 kHz
MP3	44.1 kHz, 48 kHz
DVD (Linear Audio)	48 kHz, 96 kHz
DVD-Audio	192 kHz
<b>Decoding</b>	16/20/24 bit linear
<b>Number of channels</b>	5.1 ch (FL, FR, SL, SR, C, SW)
<b>Frequency response</b>	20 Hz–20 kHz (+1, –2 dB)

### Pick up

<b>Beam Source</b>	Semiconductor Laser
<b>Wavelength</b>	
DVD	658 nm
VCD/CD	780 nm

<b>Wow and flutter</b>	Less than possible measurement data
<b>D/A converter</b>	Delta sigma DAC

### HT900

### Digital Input (for Dolby Digital)

<b>Optical In</b>	
<b>Sampling frequency</b>	32 kHz, 44.1 kHz, 48 kHz

## SPEAKER SECTION

### HT900 Front/Surround speakers SB-FS900

Type	2 Way, 2 Speaker, Bass-ref.
Speaker unit	
Full range	6.5 cm (2 <sup>1</sup> / <sub>2</sub> " cone type, 6 Ω
Super tweeter	PIEZO type
Input power	60 W (Music)
Output sound pressure level	79 dB/W (1.0 m)
Crossover frequency	10 kHz
Frequency range	85 Hz–25 kHz (–16 dB) 90 Hz–22 kHz (–10 dB)
Dimensions (W×H×D) (with stand)	250×1061.5×250 mm (9 <sup>27</sup> / <sub>32</sub> "×41 <sup>25</sup> / <sub>32</sub> "×9 <sup>27</sup> / <sub>32</sub> "
Mass (with stand)	4.1 kg (9.0 lb.)

### HT900 Center speaker SB-PC701

Type	2 Way, 3 Speaker, Bass-ref.
Speaker unit	
Full range	6.5 cm (2 <sup>1</sup> / <sub>2</sub> " cone type×2, 6 Ω
Super tweeter	PIEZO type
Input power (with filter)	220 W (Music)
Output sound pressure level	82 dB/W (1.0 m)
Crossover frequency	10 kHz
Frequency range	110 Hz–25 kHz (–16 dB) 130 Hz–22 kHz (–10 dB)
Dimensions (W×H×D) (with stand)	250×140×145 mm (9 <sup>27</sup> / <sub>32</sub> "×5 <sup>1</sup> / <sub>2</sub> "×5 <sup>23</sup> / <sub>32</sub> "
Mass (with stand)	1.6 kg (3.5 lb.)

### HT700 HT690 Front/Surround speakers SB-FS803A

Type	1 Way, 1 Speaker, Bass-ref.
Speaker unit	
Full range	6.5 cm (2 <sup>1</sup> / <sub>2</sub> " cone type, 6 Ω
Input power	60 W (Music)
Output sound pressure level	79 dB/W (1.0 m)
Frequency range	110 Hz–25 kHz (–16 dB) 130 Hz–22 kHz (–10 dB)
Dimensions (W×H×D)	92×183×90 mm (3 <sup>5</sup> / <sub>8</sub> "×7 <sup>7</sup> / <sub>32</sub> "×3 <sup>17</sup> / <sub>32</sub> "
Mass	0.86 kg (1.9 lb.)

### HT700 HT690 Center speaker SB-PC703

Type	1 Way, 2 Speaker, Bass-ref.
Speaker unit	
Full range	6.5 cm (2 <sup>1</sup> / <sub>2</sub> " cone type×2, 6 Ω
Input power (with filter)	220 W (Music)
Output sound pressure level	82 dB/W (1.0 m)
Frequency range	110 Hz–25 kHz (–16 dB) 130 Hz–22 kHz (–10 dB)
Dimensions (W×H×D)	250×95×100 mm (9 <sup>27</sup> / <sub>32</sub> "×3 <sup>3</sup> / <sub>4</sub> "×3 <sup>15</sup> / <sub>16</sub> "
Mass	1.48 kg (3.2 lb.)

### HT900 Active subwoofer SB-WA350

### HT700 Active subwoofer SB-WA340

### HT690 Active subwoofer SB-WA342

Type	1 Way, 1 Speaker, Bass-ref.
Speaker unit	
Woofer	17 cm (6 <sup>3</sup> / <sub>4</sub> " cone type 4 Ω
Input power	240 W (Music)
Output sound pressure level	80 dB/W (1.0 m)
Frequency range	40 Hz–220 Hz (–16 dB) 45 Hz–180 Hz (–10 dB)
Dimensions (W×H×D)	160×450×424 mm (6 <sup>5</sup> / <sub>16</sub> "×17 <sup>23</sup> / <sub>32</sub> "×16 <sup>11</sup> / <sub>16</sub> "
Mass	
HT900	12 kg (26.5 lb.)
HT700 HT690	11.5 kg (25.4 lb.)
For units with PX printed on the outer packaging and Latin America	12 kg (26.5 lb.)

## GENERAL

### Power supply

#### For U.S.A. and Canada

AC 120 V, 60 Hz

#### For others

AC 110 V/127 V/220–230 V/240 V, 50/60 Hz

### Power consumption

#### HT900

Main unit 25 W

Subwoofer 290 W

#### HT700 HT690

Main unit 25 W

Subwoofer 250 W

### Dimensions (W×H×D)

430×67×429 mm  
(16<sup>15</sup>/<sub>16</sub>"×2<sup>5</sup>/<sub>8</sub>"×16<sup>7</sup>/<sub>8</sub>"

### Mass

#### HT900

4.4 kg (9.7 lb.)

#### HT700 HT690

4.3 kg (9.5 lb.)

### Power consumption in standby mode

#### For U.S.A. and Canada

0.5 W

#### For others

0.9 W

### Note

- Specifications are subject to change without notice. Mass and dimensions are approximate.
- Total harmonic distortion is measured by the digital spectrum analyzer.

# Troubleshooting guide

Before requesting service, make the below checks. If you are in doubt about some of the check points, or if the remedies indicated in the chart do not solve the problem:

**In the U.S.A., contact the Panasonic Customer Call Center at 1-800-211-7262, or e-mail [consumerproducts@panasonic.com](mailto:consumerproducts@panasonic.com), or the website (<http://www.panasonic.com>).**

**In Canada, contact Panasonic Canada Inc. Customer Care Centre at 1-800-561-5505, or visit the website ([www.panasonic.ca](http://www.panasonic.ca)), or an authorized Servicentre closest to you.**

**In other areas, consult your dealer.**

## Power

		Page
No power.	● Insert the AC power supply cord and system cable securely.	10
The unit is automatically switched to the standby mode.	● The unit was switched to standby by the sleep timer.	31

## Operation

No response when buttons pressed.	<ul style="list-style-type: none"> <li>● Some operations may be prohibited by the disc.</li> <li>● The unit may not be operating properly due to lightning, static electricity or some other external factor.</li> </ul> <p><b>Reset procedure:</b> Press [⏻] to switch the unit to the standby mode and then back to ON. Alternatively, press [⏻] to switch the unit to the standby mode, disconnect the AC power supply cord, and then reconnect it.</p>	— —
No operations can be performed with the remote control.	<ul style="list-style-type: none"> <li>● Check that the batteries are installed correctly.</li> <li>● The batteries are depleted: Replace them with new ones.</li> <li>● Point the remote control at the remote control sensor and operate.</li> </ul>	10 10 —
Cannot switch on the television with the remote control.	● Press [TV] first to operate the television.	—
Play doesn't start (or stops immediately) when you press [▶] (play).	<ul style="list-style-type: none"> <li>● Condensation has formed: Wait 1 to 2 hours for it to evaporate.</li> <li>● This unit cannot play discs other than the ones listed in these operating instructions.</li> <li>● You can only play DVD-Video if their region number is the same or includes the same region number as the unit or if DVD-Video is marked "ALL". Confirm the region number for the unit on the rear panel.</li> <li>● The disc may be dirty and may require cleaning.</li> <li>● Ensure that the disc is installed with the label of the side to be played facing upwards.</li> <li>● Check that the DVD-RAM has something recorded on it.</li> </ul>	— 5 <b>Cover</b> 5 14 —
Cannot select alternative languages.	<ul style="list-style-type: none"> <li>● This function is dependent on software availability.</li> <li>● Try selecting from the disc's menu if one is available.</li> </ul>	— 14
No menu play.	● This function is dependent on software availability.	—
No subtitles.	<ul style="list-style-type: none"> <li>● This function is dependent on software availability.</li> <li>● Subtitles are cleared from the television. Display the subtitles.</li> </ul>	— 18
The position of the subtitles is incorrect.	● Change the position of the subtitles with "Subtitle Position" in the on-screen icon menus.	26
Soundtrack and/or subtitle language is not the one selected with the SETUP menus.	● This function is dependent on software availability.	—
Cannot change angle.	● This function is dependent on software availability. Even if a disc has a number of angles recorded, these angles may be recorded for specific scenes only.	—
The SETUP menu cannot be accessed.	<ul style="list-style-type: none"> <li>● Select "DVD/CD" as the source.</li> <li>● Cancel all group, program and random play.</li> </ul>	— 19
Cannot add markers.	● You cannot add markers while playing a play list or if the disc's play time doesn't appear on the unit's display.	—
There are already markers. <b>RAM</b>	● The unit reads and displays the markers added with a DVD video recorder. You can clear them but reappear when you switch the unit to standby, change the source, or change the disc.	—
Marker numbers I added are different when I call them up. <b>RAM</b>	● The unit numbers markers by time so they change when you add and delete them.	—
Cannot select random or program play.	● You cannot select random or program play with some DVD-Video.	—
Folders deeper than the eighth layer on a data CD are not displayed correctly.	● Folders deeper than the eighth layer are displayed as the eighth layer.	—
You have forgotten your ratings password. Reset all the SETUP settings to Factory Preset.	● While stopped and "DVD/CD" is the source, press and hold [■] on the unit and [≥10] on the remote control for about 3 seconds until "Initialized" disappears from the television. Turn the unit off and on again. All settings will return to the default values.	—



## Sound

<b>No sound.</b>	<ul style="list-style-type: none"> <li>● Check the connections.</li> <li>● Turn the volume up.</li> <li>● Turn muting off.</li> <li>● Switch off the unit, determine and correct the cause, then switch the unit on. Causes include:                             <ul style="list-style-type: none"> <li>– Shorting (bare wires touching) of positive and negative speaker wires.</li> <li>– Using speakers with an impedance lower than that rated for this unit.</li> <li>– Straining of the speakers through excessive volume or power.</li> <li>– Using the unit in a hot environment without proper ventilation.</li> </ul> </li> </ul>	<b>6, 8</b>
<b>Distorted sound.</b>		—
		<b>31</b>
		—
<b>Humming heard during play.</b>	<ul style="list-style-type: none"> <li>● An AC power supply cord or fluorescent light is near the subwoofer. Keep other appliances and cords away from the subwoofer.</li> </ul>	—

## Picture

<b>Picture distorted.</b>	<ul style="list-style-type: none"> <li>● Some distortion is normal during SEARCH.</li> </ul>	—
<b>No picture.</b>	<ul style="list-style-type: none"> <li>● Check the connection.</li> <li>● Make sure the television is on.</li> <li>● Ensure the television's video input setting (e.g., VIDEO 1) is correct.</li> </ul>	<b>9</b>
		—
		—
<b>The picture shown on the television is not normal. (The sides of the picture are cut off, the picture is stretched horizontally, or black bands appear at the top and bottom of the screen.)</b>	<ul style="list-style-type: none"> <li>● Go to Video in the SETUP menus, and change "TV Aspect" to suit your television.</li> <li>● Use the television to change the aspect to the correct one. <b>If your television cannot change the aspect when input is progressive</b>, try changing 4:3 Aspect with the on-screen menu icons.</li> <li>● Ensure that the unit is connected directly to the television, and is not connected through a video cassette recorder.</li> <li>● Connect to the component video (480P) input terminals on a television compatible with this unit's copy guard system. You cannot view progressive video if your television is not compatible.</li> <li>● Change the size with the variable zoom function.</li> <li>● The images on PAL system DVD-Audio are compressed for display. They may also appear vertically stretched.</li> </ul>	<b>34</b> <b>26</b>
		—
		<b>9</b>
		<b>20</b>
		—
<b>There is ghosting when progressive output is on.</b>	<ul style="list-style-type: none"> <li>● Press [PROGRESSIVE] so the indicator goes out. This problem is caused by the editing method or material used on DVD-Video, but should be corrected if you use interlace output.</li> </ul>	<b>14</b>
<b>Picture quality is poor.</b>	<ul style="list-style-type: none"> <li>● Check the settings in the On-Screen Menu Icons' Picture Menu.</li> </ul>	<b>26</b>
<b>The picture on the television disappears or stripes appear on the screen.</b>	<ul style="list-style-type: none"> <li>● Mobile telephone chargers can cause some disturbance.</li> <li>● The location and orientation of the antenna are incorrect. If you are using an indoor antenna, change to an outdoor antenna.</li> <li>● The television antenna wire is too close to the unit. Separate the antenna wire of the television from the unit.</li> </ul>	— <b>36</b> —
<b>Menus not displayed correctly.</b>	<ul style="list-style-type: none"> <li>● Change the zoom ratio to "×1.00".</li> <li>● With the on-screen icon menus, change "Subtitle Position" to "0" or change "4:3 Aspect" to "Normal".</li> </ul>	<b>20</b> <b>26</b>

## Listening to the radio

<b>Noise is heard.</b>	<ul style="list-style-type: none"> <li>● Adjust the position of the FM or AM antenna.</li> <li>● Use an outdoor antenna.</li> </ul>	—
<b>"ST" flickers or doesn't light.</b>		<b>36</b>
<b>Sound is distorted.</b>		—
<b>A beat sound is heard.</b>	<ul style="list-style-type: none"> <li>● Turn the television off or separate it from the unit.</li> </ul>	—
<b>A low hum is heard during AM broadcasts.</b>	<ul style="list-style-type: none"> <li>● Separate the antenna from other cables and cords.</li> </ul>	—

Unit displays

The display is dark.	● Press [SHIFT]+[FL DISPLAY] to brighten the display.	31
“NO PLAY”	● You inserted a disc the unit cannot play; insert one it can. ● You inserted a blank DVD-RAM.	5 —
“NO DISC”	● You haven't inserted a disc; insert one. ● You haven't inserted the disc correctly; insert it correctly.	— 14
“F61”	● Check and correct the speaker cord connections. If this does not fix the problem, there is a power supply problem. Consult the dealer.	6, 8
“DVD U11”	● Disc is dirty. Wipe it clean.	5
“ERROR”	● Incorrect operation performed. Read the instructions and try again.	—
“DVD H□□” □□ stands for a number.	● Trouble may have occurred. The number following “H” depends on the status of the unit. <b>Reset procedure:</b> Press [⏻] to switch the unit to the standby mode and then back to ON. Alternatively, press [⏻] to switch the unit to the standby mode, disconnect the AC power supply cord, and then reconnect it. ● If the service numbers fail to clear, note the service number and contact a qualified service person.	— —

Television displays

No on-screen display.	● Go to Display in the SETUP menus, and select “On” for “On-Screen Messages”.	34
On-Screen Menu Icons not displayed or only partially displayed on the television.	● Press [▲, ▼] while the rightmost icon is highlighted to move them down.	24
The disc's menu is displayed in a different language.	● Go to Disc in the SETUP menus, and select the preferred language for “Menus”.	34
“Cannot display group xx, picture xx.”	● You are trying to display incompatible pictures.	—

Product Service (U.S.A. and Canada)

- 1. Damage requiring service**—The unit should be serviced by qualified service personnel if:
  - (a) The AC power supply cord or AC adaptor has been damaged; or
  - (b) Objects or liquids have gotten into the unit; or
  - (c) The unit has been exposed to rain; or
  - (d) The unit does not operate normally or exhibits a marked change in performance; or
  - (e) The unit has been dropped or the cabinet damaged.
- 2. Servicing**—Do not attempt to service the unit beyond that described in these operating instructions. Refer all other servicing to authorized servicing personnel.
- 3. Replacement parts**—When parts need replacing ensure the servicer uses parts specified by the manufacturer or parts that have the same characteristics as the original parts. Unauthorized substitutes may result in fire, electric shock, or other hazards.
- 4. Safety check**—After repairs or service, ask the servicer to perform safety checks to confirm that the unit is in proper working condition.

The servicer will require all components to service your system. Therefore, should service ever be necessary, be sure to bring the entire system.

Product information

For product information or assistance with product operation:

In the U.S.A., contact the Panasonic Customer Call Center at 1-800-211-7262, or e-mail [consumerproducts@panasonic.com](mailto:consumerproducts@panasonic.com), or the website (<http://www.panasonic.com>).  
In Canada, contact Panasonic Canada Inc. Customer Care Centre at 1-800-561-5505, or visit the website ([www.panasonic.ca](http://www.panasonic.ca)), or an authorized Servicentre closest to you.

Maintenance

- To clean this unit, wipe with a soft, dry cloth.**
- Never use alcohol, paint thinner or benzine to clean this unit.
  - Before using chemically treated cloth, read the instructions that came with the cloth carefully.

**Before moving the unit, ensure the disc trays are empty.**  
**Failure to do so will risk severely damaging the discs and the unit.**

# Limited Warranty (U.S.A.)

Panasonic Consumer Electronics Company,  
Division of Matsushita Electric Corporation of America  
One Panasonic Way Secaucus, New Jersey 07094

Panasonic Sales Company, Division of Matsushita Electric of Puerto Rico, Inc.  
Ave. 65 de Infantería, Km. 9.5  
San Gabriel Industrial Park, Carolina, Puerto Rico 00985

## Panasonic/Technics Audio Products Limited Warranty

### Limited Warranty Coverage

If your product does not work properly because of a defect in materials or workmanship, Panasonic Consumer Electronics Company or Panasonic Sales Company (collectively referred to as "the warrantor") will, for the length of the period indicated on the chart below, which starts with the date of original purchase ("warranty period"), at its option either (a) repair your product with new or refurbished parts, or (b) replace it with a new or a refurbished product. The decision to repair or replace will be made by the warrantor.

Product or Part Name	Parts	Labor
Audio Products (except items listed below)	One (1) year	One (1) year
All Audio Racks (cabinets)	Thirty (30) days	Not Applicable
Technics Stand Alone Speakers, Subwoofer Speakers	Three (3) years	Three (3) years
USB Reader-Writer, Personal Computer Card Adapters (in exchange for defective item)	One (1) year	Not Applicable
Accessories: Headphones, Cartridges, Microphones, Adapters	Ninety (90) days	Ninety (90) days
Rechargeable Batteries (in exchange for defective item)	Ten (10) days	Not Applicable
SD Memory Cards, Rechargeable Battery Packs (in exchange for defective item)	Ninety (90) days	Not Applicable

During the "Labor" warranty period there will be no charge for labor. During the "Parts" warranty period, there will be no charge for parts. You must carry-in or mail-in your product during the warranty period. If non-rechargeable batteries are included, they are not warranted. This warranty only applies to products purchased and serviced in the United States or Puerto Rico. This warranty is extended only to the original purchaser of a new product which was not sold "as is". A purchase receipt or other proof of the original purchase date is required for warranty service.

### Carry-In or Mail-In Service

For Carry-In or Mail-In Service in the United States call 1-800-211-PANA (1-800-211-7262) or visit Panasonic web site: <http://www.panasonic.com>  
For assistance in Puerto Rico call Panasonic Sales Company (787)-750-4300 or fax (787)-768-2910.

### Limited Warranty Limits And Exclusions

This warranty ONLY COVERS failures due to defects in materials or workmanship, and DOES NOT COVER normal wear and tear or cosmetic damage. The warranty ALSO DOES NOT COVER damages which occurred in shipment, or failures which are caused by products not supplied by the warrantor, or failures which result from accidents, misuse, abuse, neglect, mishandling, misapplication, alteration, faulty installation, set-up adjustments, misadjustment of consumer controls, improper maintenance, power line surge, lightning damage, modification, or commercial use (such as in a hotel, office, restaurant, or other business), rental use of the product, service by anyone other than a Factory Servicenter or other Authorized Servicer, or damage that is attributable to acts of God.

**THERE ARE NO EXPRESS WARRANTIES EXCEPT AS LISTED UNDER "LIMITED WARRANTY COVERAGE". THE WARRANTOR IS NOT LIABLE FOR INCIDENTAL OR CONSEQUENTIAL DAMAGES RESULTING FROM THE USE OF THIS PRODUCT, OR ARISING OUT OF ANY BREACH OF THIS WARRANTY.** (As examples, this excludes damages for lost time, travel to and from the servicer, loss of media or images, data or other memory content. The items listed are not exclusive, but are for illustration only.) **ALL EXPRESS AND IMPLIED WARRANTIES, INCLUDING THE WARRANTY OF MERCHANTABILITY, ARE LIMITED TO THE PERIOD OF THE LIMITED WARRANTY.**

Some states do not allow the exclusion or limitation of incidental or consequential damages, or limitations on how long an implied warranty lasts, so the exclusions may not apply to you. This warranty gives you specific legal rights and you may also have other rights which vary from state to state. If a problem with this product develops during or after the warranty period, you may contact your dealer or Servicenter. If the problem is not handled to your satisfaction, then write to the warrantor's Consumer Affairs Department at the addresses listed for the warrantor.

**PARTS AND SERVICE WHICH ARE NOT COVERED BY THIS LIMITED WARRANTY ARE YOUR RESPONSIBILITY.**

## Customer Services Directory

**For Product Information, Operating Assistance, Literature Request, Dealer Locations, and all Customer Service inquiries please contact:  
1-800-211-PANA (7262), Monday-Friday 9 am-9 pm; Saturday-Sunday 9 am-7 pm, EST.  
or send e-mail:  
[consumerproducts@panasonic.com](mailto:consumerproducts@panasonic.com)  
For hearing or speech impaired TTY users, TTY: 1-877-833-8855**

**Web Site: <http://www.panasonic.com>  
You can purchase parts, accessories or locate your nearest servicenter by visiting our Web Site.**

### Accessory Purchases:

1-800-332-5368 (Customer Orders Only)  
For hearing or speech impaired TTY users, TTY: 1-866-605-1277  
Panasonic Services Company 20421 84th Avenue South, Kent, WA 98032  
(6 am to 5 pm Monday-Friday; 6 am to 10:30 am Saturday; PST)  
(Visa, MasterCard, Discover Card, American Express, Check)

### Service in Puerto Rico

**Matsushita Electric of Puerto Rico, Inc. Panasonic Sales Company/Factory Servicenter:  
Ave. 65 de Infantería, Km. 9.5, San Gabriel Industrial Park, Carolina, Puerto Rico 00985  
Phone (787) 750-4300 Fax (787) 768-2910**

# Listening caution



Selecting fine audio equipment such as the unit you've just purchased is only the start of your musical enjoyment. Now it's time to consider how you can maximize the fun and excitement your equipment offers. This manufacturer and the Electronic Industries Association's Consumer Electronics Group want you to get the most out of your equipment by playing it at a safe level. One that lets the sound come through loud and clear without annoying blaring or distortion—and, most importantly, without affecting your sensitive hearing.

We recommend that you avoid prolonged exposure to excessive noise.

Sound can be deceiving. Over time your hearing "comfort level" adapts to higher volumes of sound. So what sounds "normal" can actually be loud and harmful to your hearing.

Guard against this by setting your equipment at a safe level BEFORE your hearing adapts.

To establish a safe level:

- Start your volume control at a low setting.
- Slowly increase the sound until you can hear it comfortably and clearly, and without distortion.

Once you have established a comfortable sound level:

- Set the dial and leave it there.

Taking a minute to do this now will help to prevent hearing damage or loss in the future. After all, we want you listening for a lifetime.

This product may receive radio interference caused by mobile telephones during use. If such interference is apparent, please increase separation between the product and the mobile telephone.

Manufactured under license from Dolby Laboratories. "Dolby", "Pro Logic" and the double-D symbol are trademarks of Dolby Laboratories.

Manufactured under license from Digital Theater Systems, Inc. US Pat. No. 5,451,942, 5,956,674, 5,974,380, 5,978,762 and other world-wide patents issued and pending. "DTS" and "DTS Digital Surround" are registered trademarks of Digital Theater Systems, Inc. Copyright 1996, 2000 Digital Theater Systems, Inc. All rights reserved.

## User memo:

DATE OF PURCHASE \_\_\_\_\_  
DEALER NAME \_\_\_\_\_  
DEALER ADDRESS \_\_\_\_\_  
TELEPHONE NUMBER \_\_\_\_\_

The model number and serial number of this product can be found on either the back or the bottom of the unit. Please note them in the space provided below and keep for future reference.

MODEL NUMBER \_\_\_\_\_  
SERIAL NUMBER \_\_\_\_\_

Apparatus Claims of U.S. Patent Nos. 4,631,603, 4,577,216, and 4,819,098, licensed for limited viewing uses only.

This product incorporates copyright protection technology that is protected by method claims of certain U.S. patents and other intellectual property rights owned by Macrovision Corporation and other rights owners. Use of this copyright protection technology must be authorized by Macrovision Corporation, and is intended for home and other limited viewing uses only unless otherwise authorized by Macrovision Corporation. Reverse engineering or disassembly is prohibited.

### For U.S.A.

#### Panasonic Consumer Electronics Company, Division of Matsushita Electric Corporation of America

One Panasonic Way Secaucus,  
New Jersey 07094  
<http://www.panasonic.com>

#### Panasonic Sales Company, Division of Matsushita Electric of Puerto Rico, Inc. ("PSC")

Ave. 65 de Infantería, Km. 9.5  
San Gabriel Industrial Park, Carolina,  
Puerto Rico 00985

### For Canada

#### Panasonic Canada Inc.

5770 Ambler Drive  
Mississauga, Ontario  
L4W 2T3  
[www.panasonic.ca](http://www.panasonic.ca)

En

### For units with PX printed on the outer packaging

#### Matsushita Electric Industrial Co., Ltd. Corporate Management Division for the Americas

Sales Office for North America  
Tokyo Panasonic Sales Section  
32nd Floor, World Trade Center 4-1,  
Hamamatsu-cho, 2-Chome, Minato-Ku,  
Tokyo 105-6132, Japan

#### Panasonic Marketing Europe G.M.B.H. Wiesbaden N. (a Division of Panasonic Marketing G.M.B.H.)

Military Sales Department  
6200 Wiesbaden-Biebrich,  
Hagenauerstr. 43  
Germany

### For others

#### Matsushita Electric Industrial Co., Ltd.

Web Site: <http://www.panasonic.co.jp/global/>